

# 2018-2019 *FIRST*<sup>®</sup> Tech Challenge Field Setup Guide

*AndyMark Field Layout and Finishing Guide for 2018-2019 FIRST<sup>®</sup> Tech Challenge*

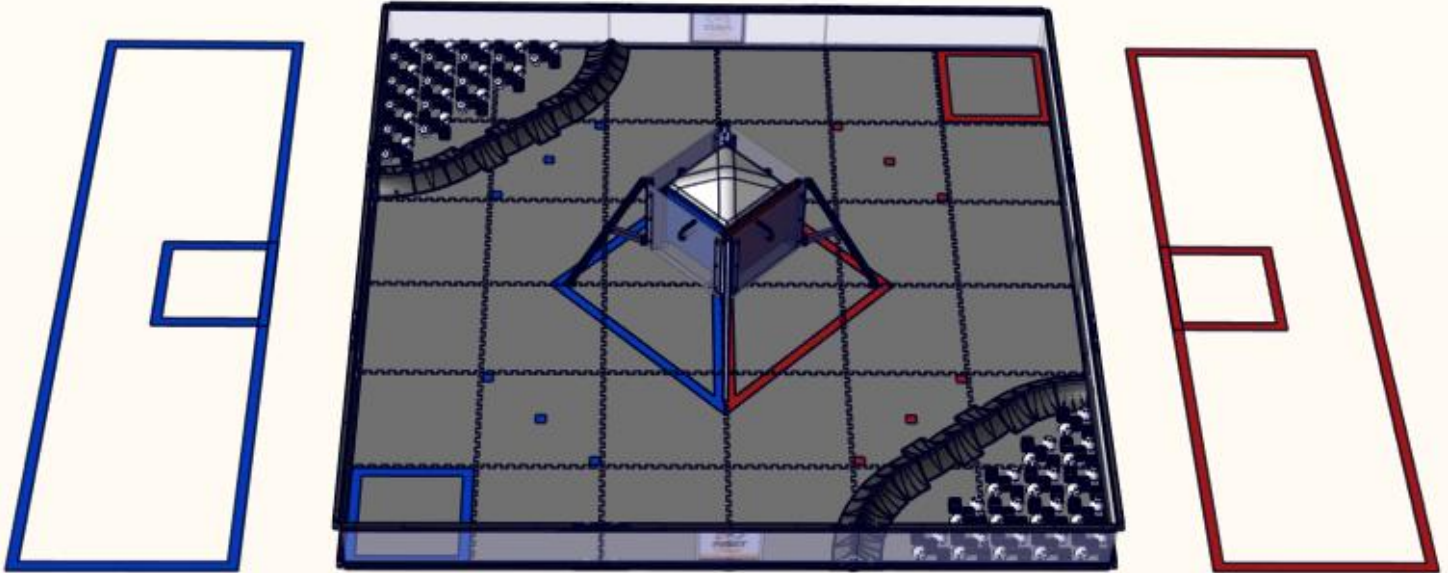

**This guide contains instructions for setting up the Field Elements for the  
2018-2019 FIRST® Tech Challenge Game**









**ROVER RUCKUS<sup>SM</sup> Presented by Qualcomm® Incorporated**

***Read through all the instructions and take a parts inventory before  
you begin to assemble and setup the game elements!***

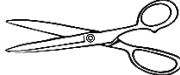

**REVISION HISTORY**

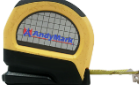
Rev.	Date	Description
1.0	8/29/18	Initial Release
1.1	9/7/18	Updates and additions for clarity
1.2	9/13/18	Updated field dimensions for the Lander, added 3-6
1.3	11/12/18	Removed Part 8



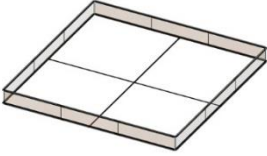

**TOOLS NEEDED**

Component	QTY	Part Photo
Safety Equipment	As Needed	
Safety Glasses	1	
Utility Knife	1	
File	1	
Scissors	1	
Diagonal Cutters	1	
Tape Measure	1	
Color Printer	1	

# FULL FIELD REQUIREMENTS

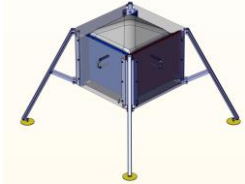
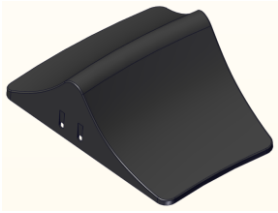
Component	Part #	QTY	Part Photo
FIRST Tech Challenge Field Perimeter	am-0481a	1	
5/8" Gray Soft Tiles	am-2499-36	36	

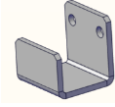
## Competition Field Components

Component	Part #	QTY	Part Photo
Lander	See Field Assembly Guide for assembly instructions.	1	
Crater Segments	See Field Assembly Guide for assembly instructions.	20	
11" Cable Tie (extras included, additional will be needed for future setups)	am-1067	22 needed each time the craters are assembled	
Lower Clip	am-3875	4	
Gold Scoring Mineral	ftc-2013	90	
Silver Scoring Mineral	am-2850	60	

<p>2" "Red" Gaffers Tape</p>	<p>am-2946</p>	<p>as needed</p>	
<p>2" "Electric Blue" Gaffers Tape</p>	<p>am-2947</p>	<p>as needed</p>	
<p>Cardstock for Navigation Target  (Printed from <a href="#">FIRST Resource Library</a>)</p>		<p>8</p>	
<p>Command Mini Hooks P/N: 17006-VP  For use with AndyMark, IFI and Logo Loc Perimeters</p>	<p>P/N: 17006-VP</p>	<p>8</p>	
<p>Velcro® Dots  For use with early generation AndyMark Perimeters</p>	<p>Roughly 3/4" diameter or larger</p>	<p>1 pack</p>	
<p>Clear Page Protection Sleeves</p>	<p>Similar to Staples P/N 40713</p>	<p>4</p>	

## Match Timer Components

Component	Detail	QTY	Part Photo
Laptop/Netbook	Running Java 1.7 or higher	1 per field	
Field Display Monitor	Roughly a 17" monitor or bigger	1 per field	
Power	For Laptops and Monitors	1 set per field	
Video Cables	For connecting Monitors to laptop	1 set	
Computer Speakers	For match sound effects	1 set per field	

# Part 1: Setting up the Floor and Field Perimeter

**Step 1-1:** Lay the tiles with the **smooth** surface facing up in a 6x6 grid pattern.

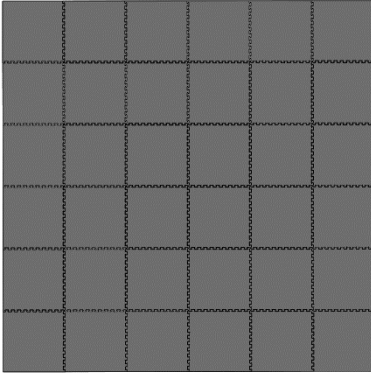

**Step 1-2: Critical Mandatory Step:** Trim all outer tabs from the 20 Soft Tiles on the outside edges of the field.

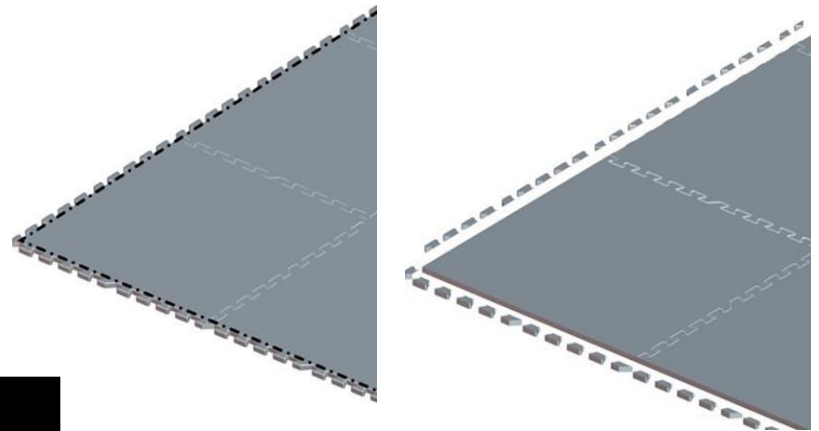

**NOTE:** Lay the tiles out and mark the outer edge to be cut. Use a sharp utility knife and a straight edge or a band saw (if available) to get a smooth clean edge.

**Step 1-3:** Note that there are several **FIRST** Tech Challenge Perimeter wall designs. The wall designs fall into two categories. The smooth/non-cavity sides should face towards the inside of the Playing Field as shown in the illustration.

Perimeter	Wall Design Categories	Wall Height
AndyMark (current)	Smooth on one side and an open cavity on the other side	12.125"
IFI Perimeter	Smooth on one side and an open cavity on the other side	11.5"
Logo Loc Perimeter	Symmetrical inside and outside surfaces	12.375"

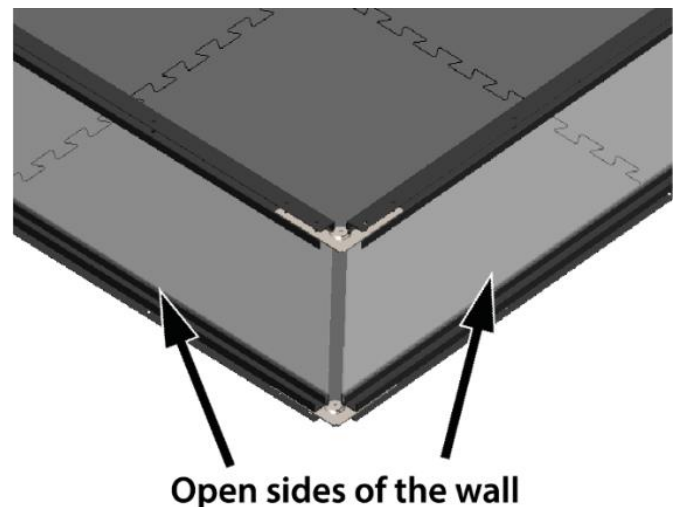
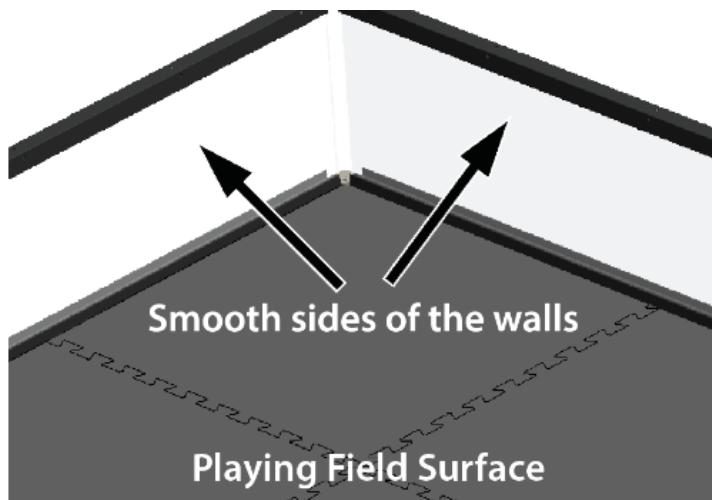

**NOTE:** If using the AndyMark Field Perimeter, ensure that straps are installed to keep walls in place during game play.

## Part 2: General Layout and Orientation

MATCH TIMER  
DISPLAY TABLE

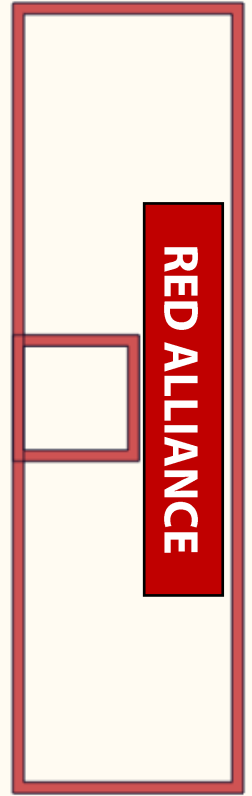
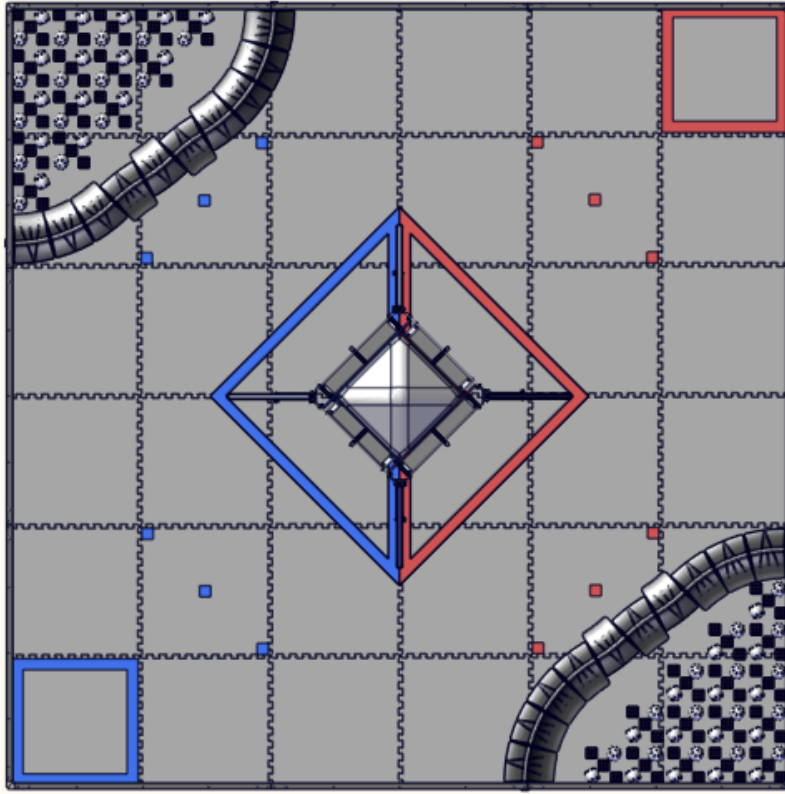
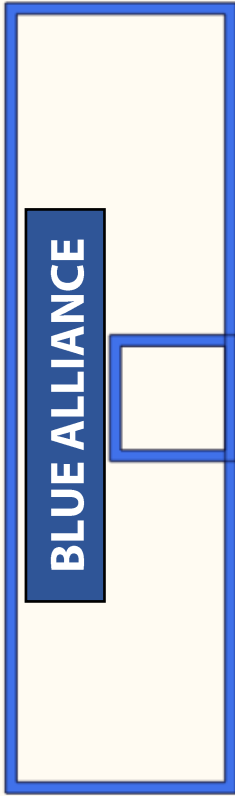

AUDIENCE

**NOTE:** The Match Timer Display table should include the timer screen as described in section 10. This should be placed to ensure that the Teams are able to see the clock and hear the timer sounds for each period of the Match.



## Part 3: Lander Placement

ROVER RUCKUS<sup>SM</sup> Presented by Qualcomm<sup>®</sup> Incorporated is played with one Lander diagonally placed in the center of the field. Build instructions can be found in the Field Assembly Guide. The BLUE side of the Lander should be placed facing the BLUE Alliance Station. The RED side of the Lander should be placed facing the RED Alliance Station. From the audience view, the RED should be placed on the right and the BLUE on the left.

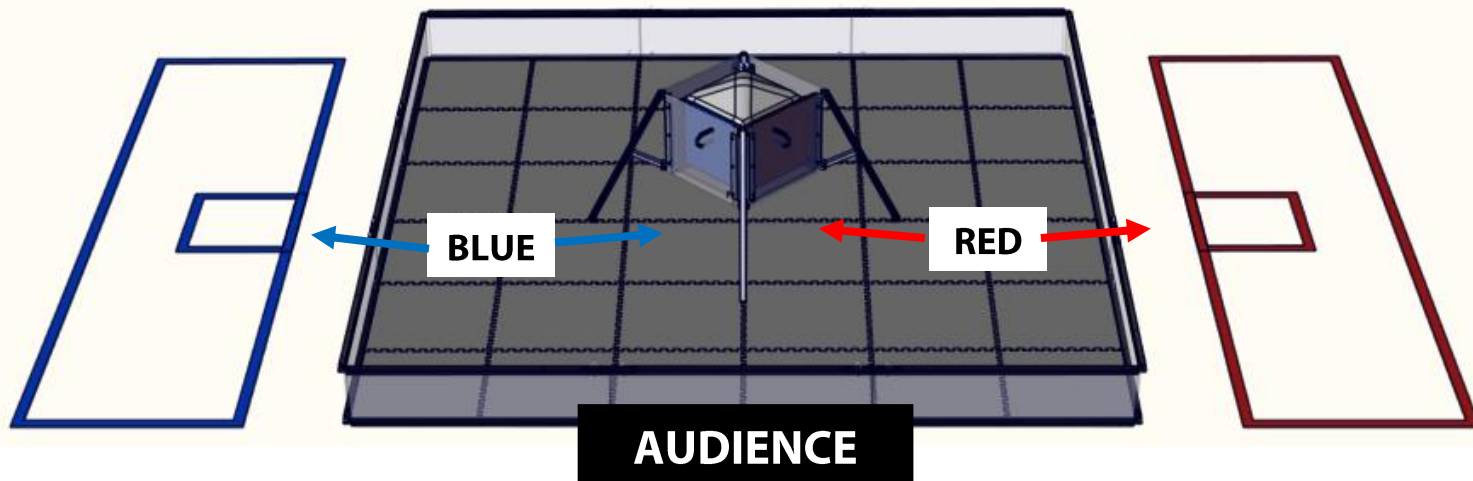

**Step 3-1:** The feet of the Lander should line up with the two center seams of the SoftTiles. When placed on the field, the Lander should be centered and the feet should be evenly spaced out from the center point. The anchor should measure 29.75" from the center of the field to the bolt on the anchor.

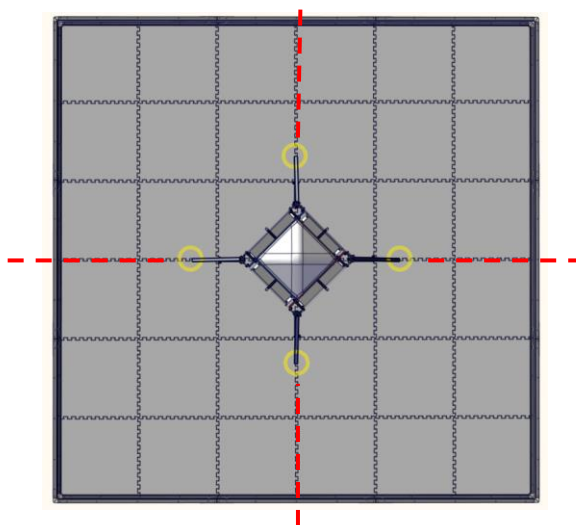

**Step 3-2:** Use the Under Tile Disk with elevator bolt and 1/4-20 Nut to anchor it into place. The SoftTiles should sit between the disk and the foot.

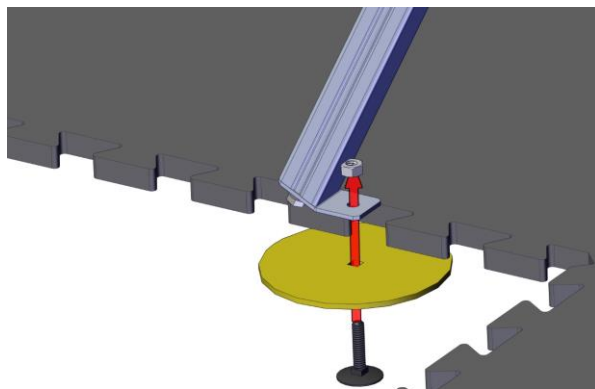

**Step 3-3:** The SoftTiles should sit flat on each intersection of the leg.

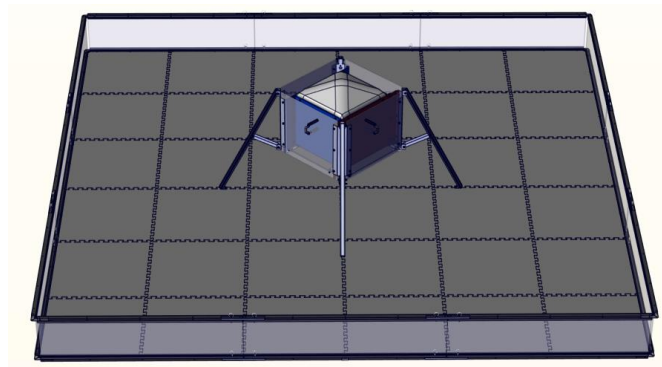



**Step 3-4:** During match play, teams will fill the sides of the Lander with Gold and Silver scoring elements. During the field reset period between matches, the pins located on each side of the lander can be removed to allow the scoring elements to fall out the bottom.

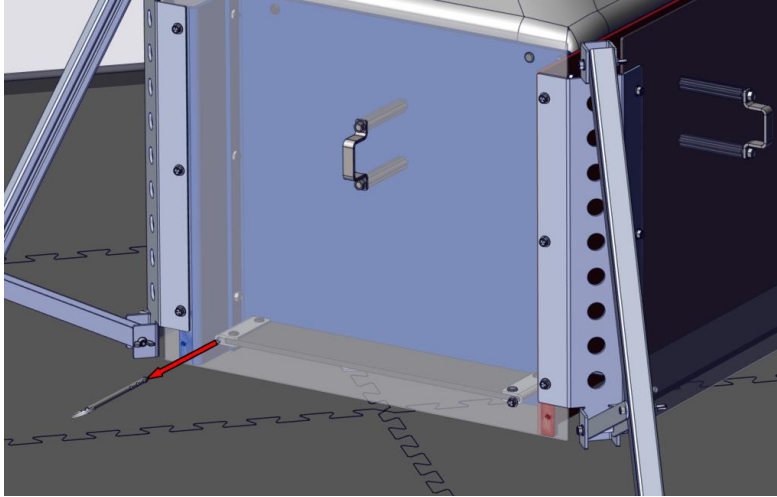

**Step 3-5:** For match play, ensure the pin is fully inserted through the floor of each side of the lander.

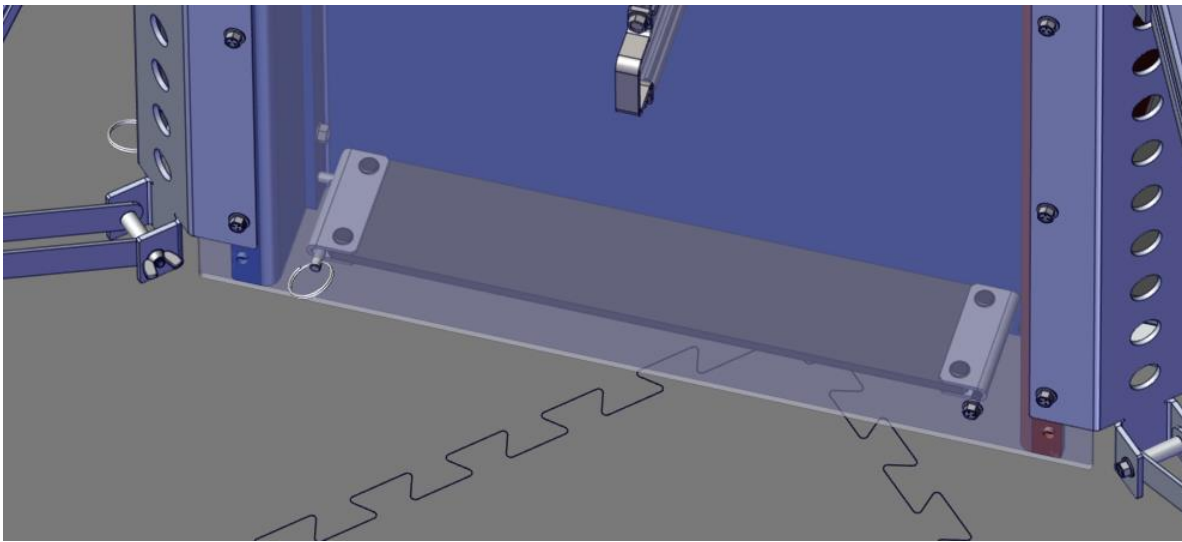

**Step 3-6:** For gameplay, ensure there is enough clearance for the game pieces. The Silver Scoring Mineral should easily slide between the Front Panels and the Internal Long Walls. All Cargo Holds should have an opening between 2.875 and 3 inches

The Gold Scoring Mineral should easily slide between the Front Panels and the Internal Short Walls.

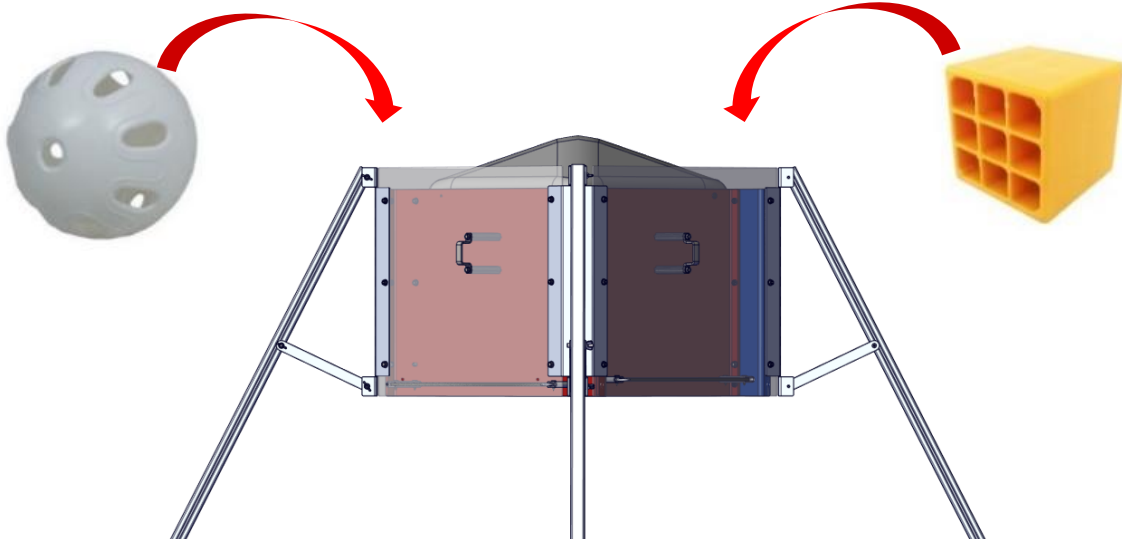

If the Minerals get stuck between the panels when they are dropped or placed in the lander, the bolts holding the panels together may be too tight. Loosen the bolts a quarter turn until the Minerals fall freely to the bottom of the lander.

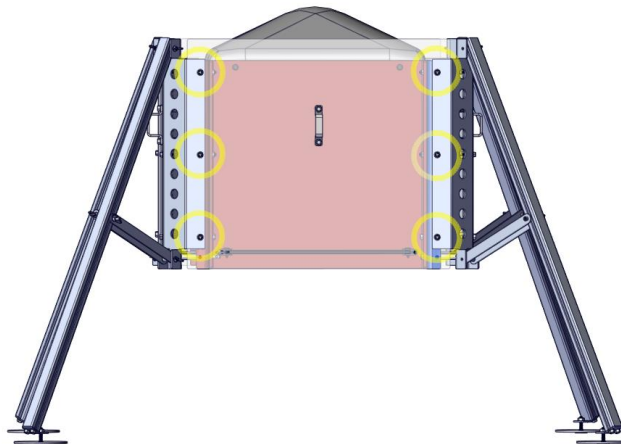

Additionally, the screw and nut holding the Ball and Cube floor panels may need to be loosened as well.

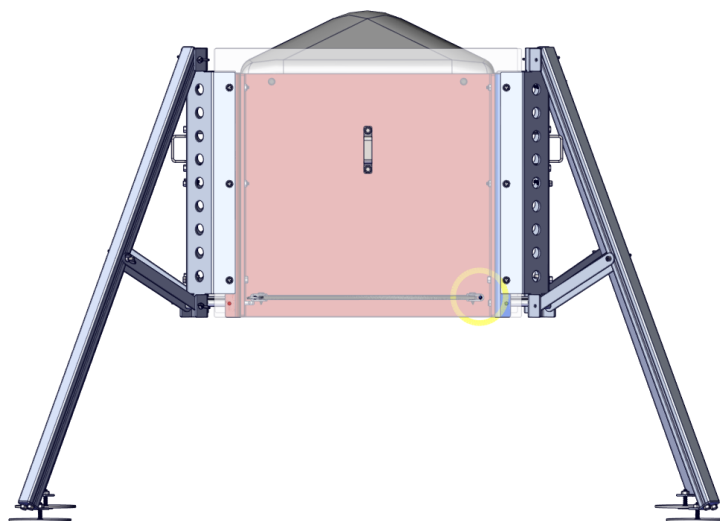

## Part 4: Crater Assembly and Placement

ROVER RUCKUS<sup>SM</sup> is played with two Craters on opposing corners of the field. From the Audience perspective a Crater should sit in the upper left corner and a Crater should sit in the lower right corner. Each Crater Section is the same and assembly instructions are as shown below.

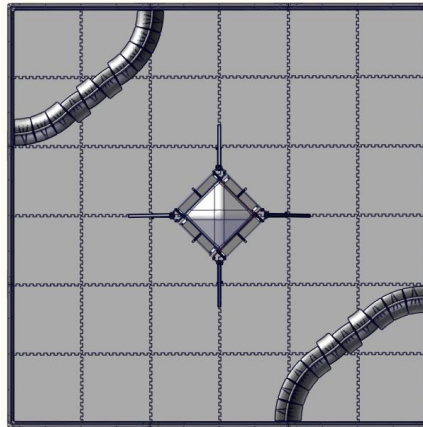

**AUDIENCE**

**Step 4-1:** Each Crater is made up of 10 Crater Segments. When counting from left to right, the 5<sup>th</sup> and 7<sup>th</sup> segments have their long side pointed outwards. The remaining segments have their long sides facing inwards.

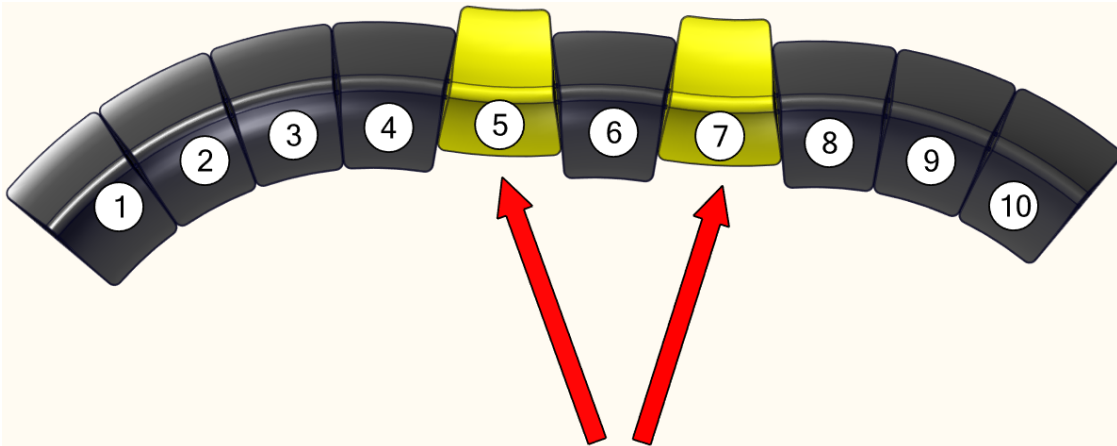

**Step 4-2:** To create a Crater, turn each segment upside down and place together. Use a cable tie to loop horizontally through the holes in each section to hold together. Tighten the cable tie down all the way so the sections don't separate. When flipped right side up, the Crater Segments should sit flat on the SoftTiles and not have any spaces between the bottom edges. Trim the ends of the cable tie.

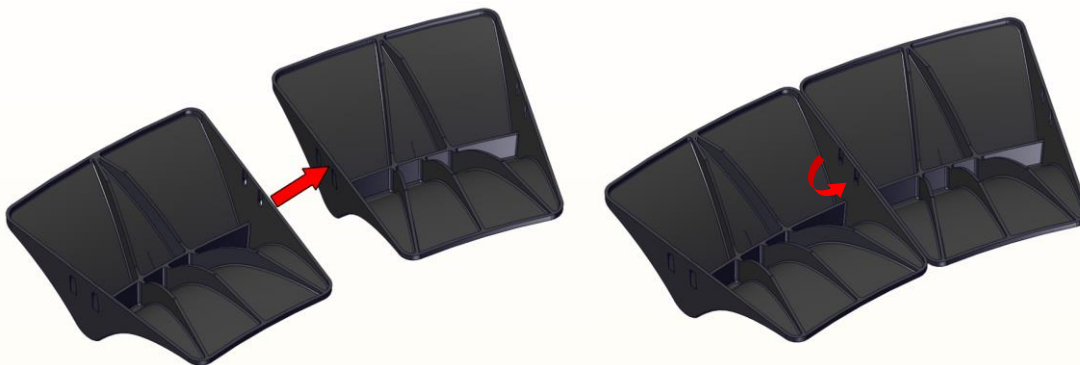

**Step 4-3:** Attach the 10 segments together. On both ends of the Crater, place a Lower Clip.

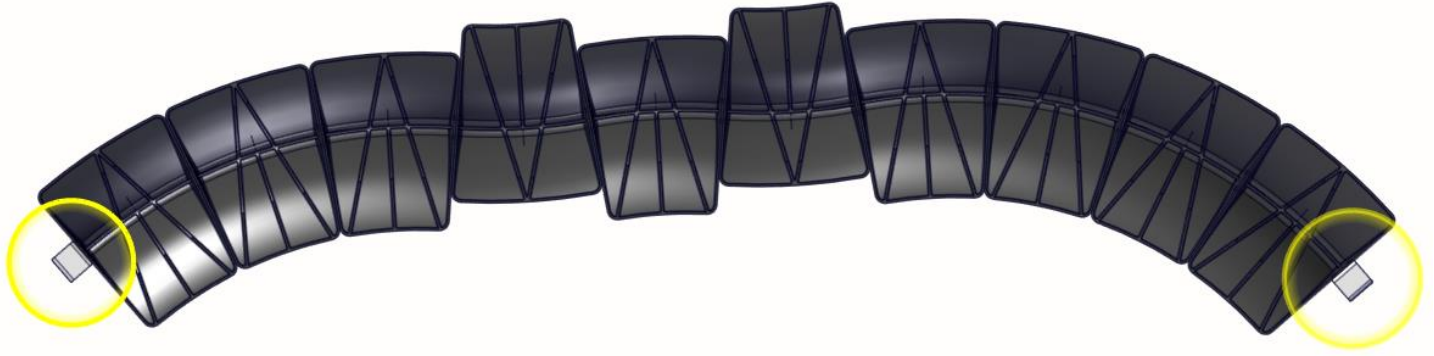

**Step 4-4:** The holes on the Lower Clip should line up with the holes in the Crater Segment. The clip should point up towards the top of the Crater.

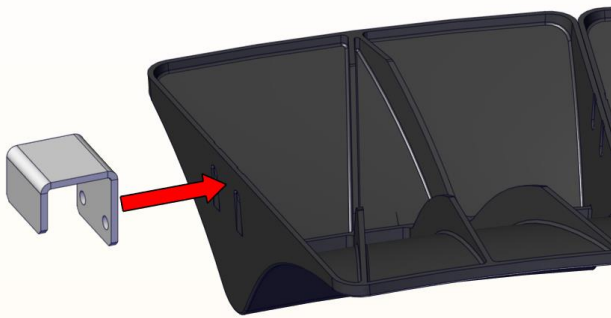

**Step 4-5:** Secure the clip to the Crater Section with a cable tie.

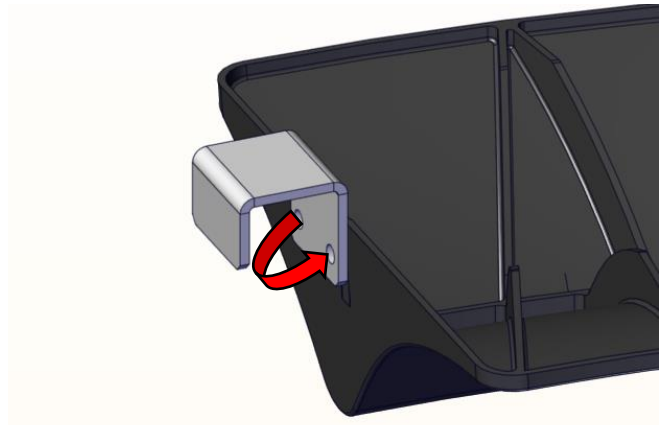

**Step 4-6:** Place each Crater into the corner of the field perimeter. From the Audience perspective a Crater should sit in the upper left corner and a Crater should sit in the lower right corner. The end Crater Segments should sit up against the field perimeter and there should be no gaps between the bottoms of the Crater Segments.

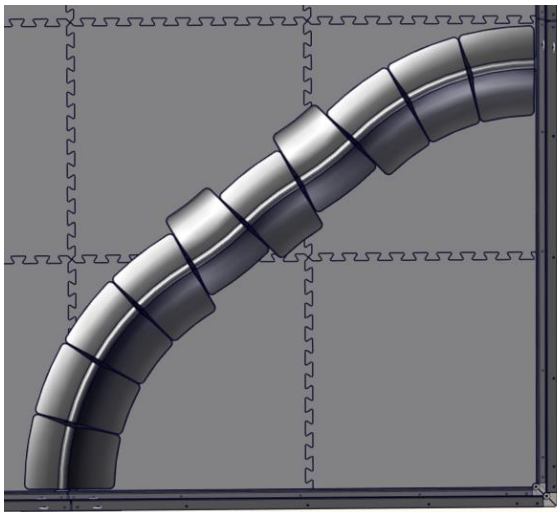

**Step 4-7:** The clip will sit underneath the field perimeter rail and secure the Crater to the perimeter.

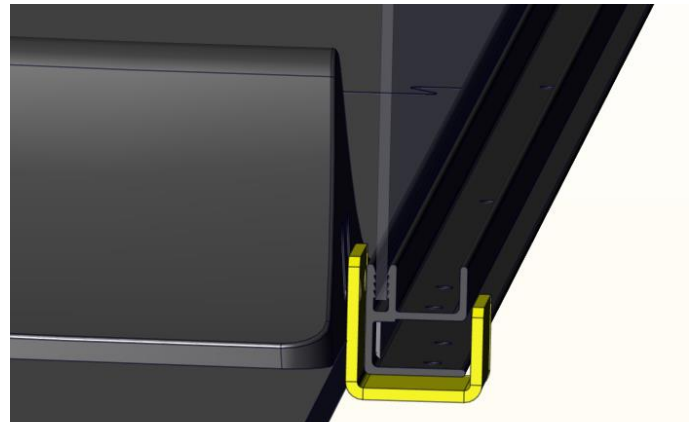

## Part 5: Game Piece Placement

**Step 5-1:** ROVER RUCKUS<sup>SM</sup> is played with two types of scoring elements, Gold and Silver. Prior to the start of each match, two Silver Minerals and one Gold Mineral are placed onto the Sample Fields. The order should be Silver, Gold, Silver. The Gold Minerals should be placed "waffle side" up.

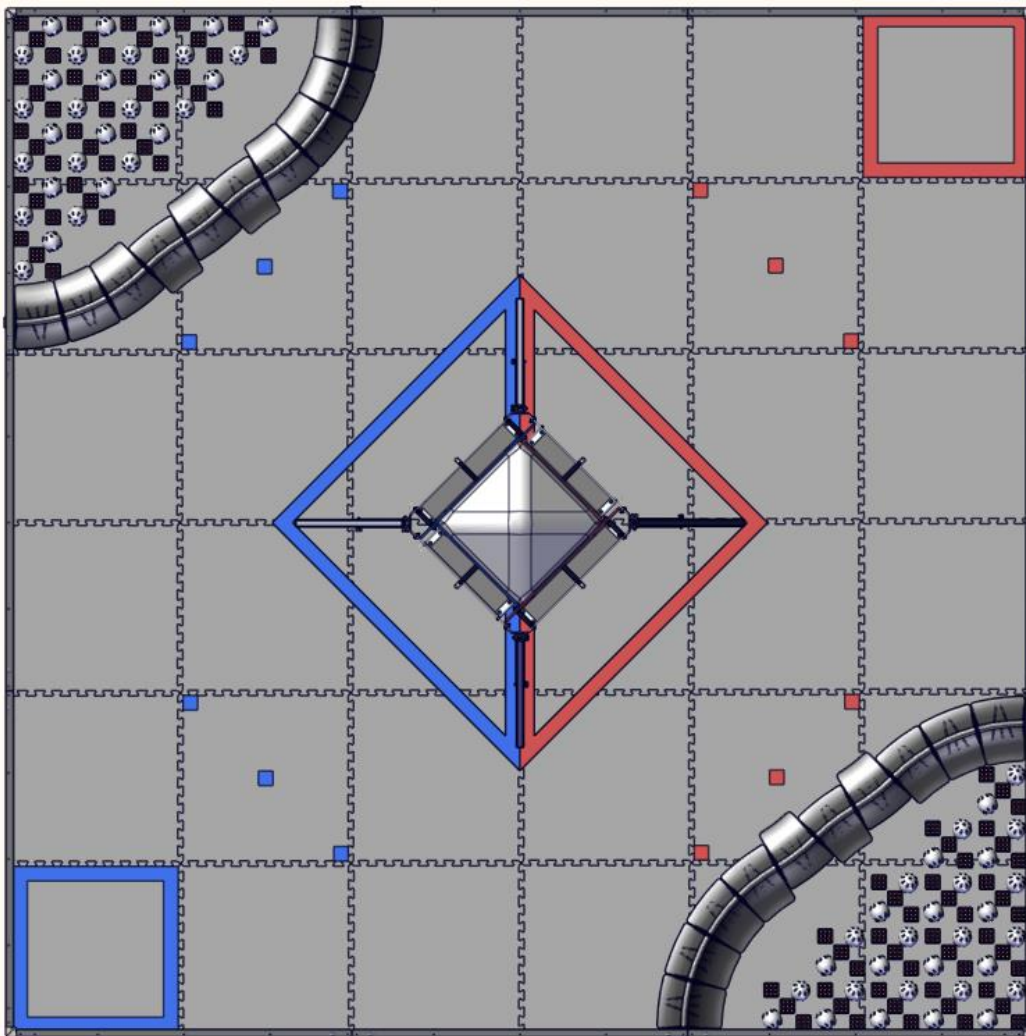

AUDIENCE

**Step 5-2:** Prior to the start of each match field personnel will place approximately half of the fifty two (52) Silver and half of the eighty six (86) Gold Minerals into each of the Craters. The Silver and Gold will be randomly mixed.



## **Part 6: Navigation Target Placement**

**Step 6-1:** Download Target Images found on the *FIRST* Tech Challenge Game and Season Info Page:  
<http://www.firstinspires.org/resource-library/ftc/game-and-season-info>

**Step 6-2:** Print the navigation targets in color, not greyscale on 8.5x11" White Cardstock. The Print resolution must be at least 300DPI. The targets can be laminated or placed in sheet protectors.



**Step 6-3:** Print the *FIRST* Tech Challenge Logo in Landscape Orientation on 8.5x11" White Cardstock. The logo should be centered and cover the nearly the entire page. This image should be on the reverse of the target image. <http://www.firstinspires.org/resource-library/ftc/game-and-season-info>

**Step 6-4:** Insert both images (target and logo) into the sheet protector sleeves. For AndyMark, IFI and LogoLoc perimeters, targets can be hung in place with Command Adhesive Mini Hooks. For early generation AndyMark Perimeters, use Velcro Dots to hang the targets.

**Step 6-5:** The navigation target should be placed on the center perimeter panel as measured from the metal perimeter border and not the polycarbonate. The bottom of the image measures 5.75 inches from the tile floor to the center of the navigation target image. The target image centerline is marked by a black line on the outside of the image.

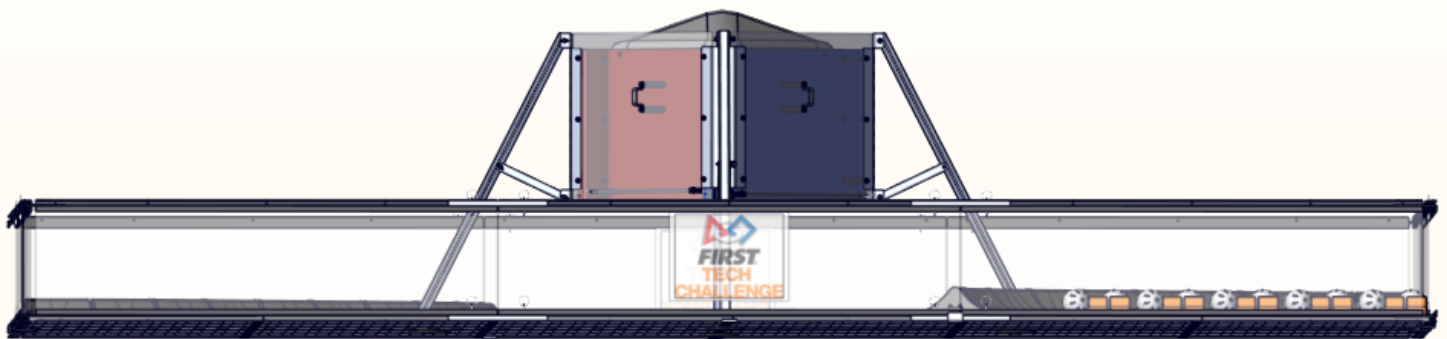

**Step 6-6:** The navigation target should be placed around the field perimeter as shown below.



Target 1  
Front Wall  
(audience facing)



Target 3  
Back Wall



Target 2  
Red Alliance Wall



Target 4  
Blue Alliance Wall

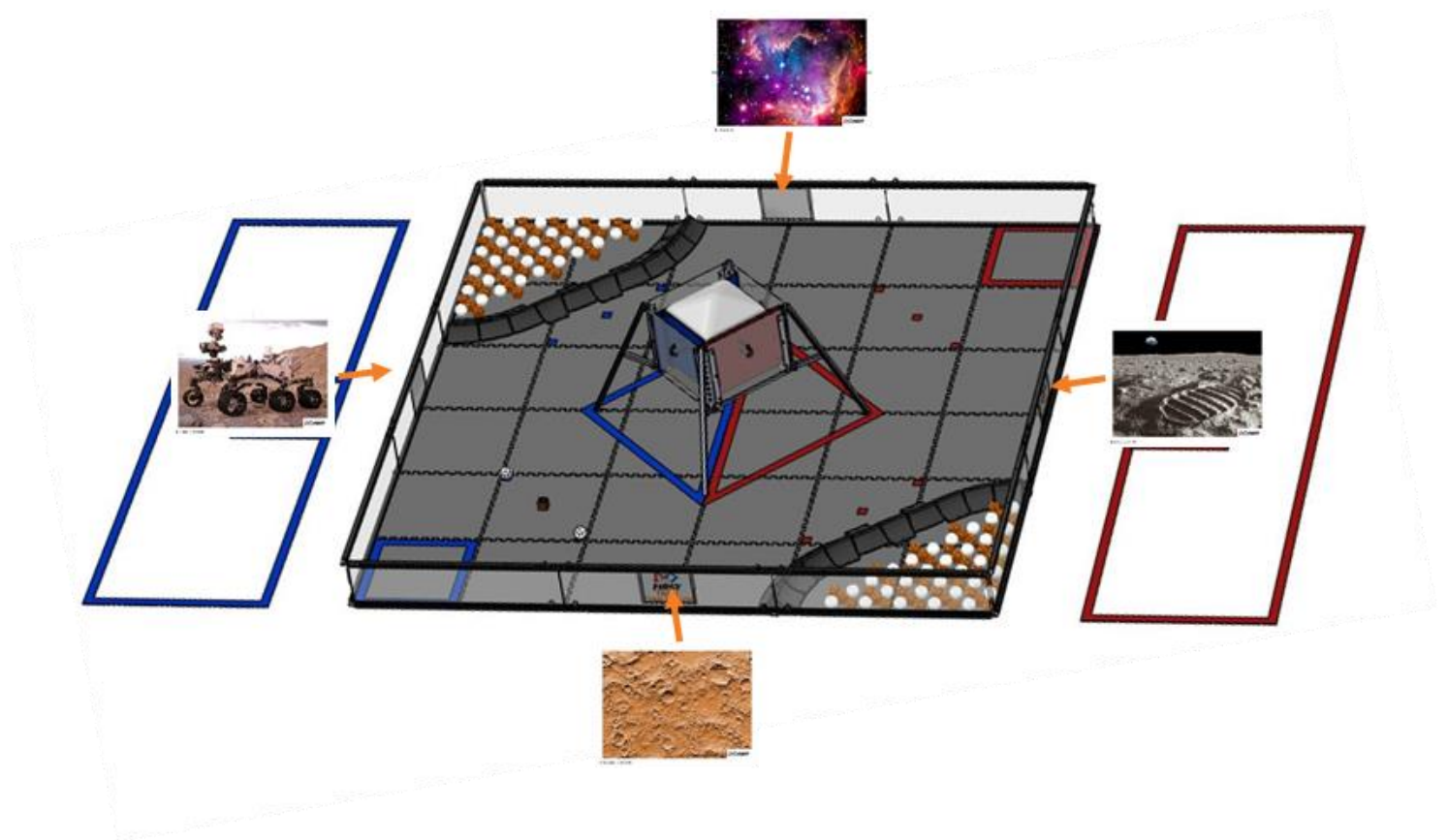



## Part 7: Tape Lines

**Step 7-1:** Use 2" RED and BLUE Gaffers Tape to mark a one-tile Depot. The BLUE Depot is located in the corner without a Crater closest towards the BLUE side of the Lander. The RED Depot is located in the opposite corner. The tape line should sit inside of the SoftTile seam and along the field perimeter as shown.

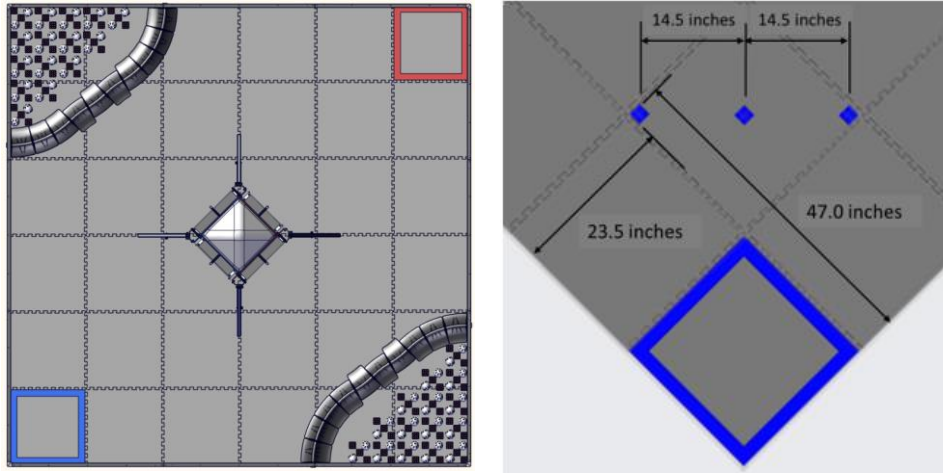

**Step 7-2:** Use 2" RED and BLUE Gaffers Tape to mark the Landing Zone under the Lander. From the Audience perspective, the RED Landing Zone is located on the right side. Tape a vertical line under the Lander extending from the near Lander Leg to the far Lander Leg. RED and BLUE tape should be placed side by side along the SoftTile seam. Tape a square around the outside of the Lander Legs. RED tape should be used adjacent to the RED faces of the Lander and BLUE tape should be used adjacent to the BLUE sides of the Lander as shown below.

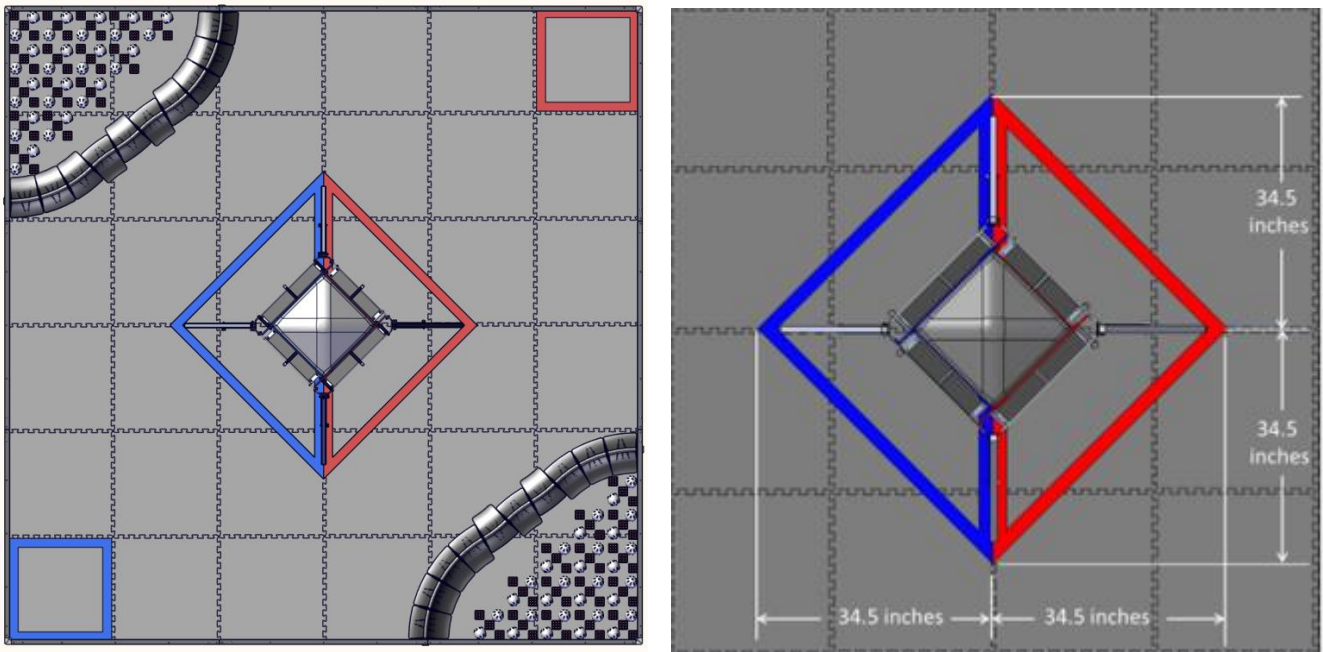

**AUDIENCE**

**Step 7-3:** Use 2" RED and BLUE Gaffers Tape to mark the scoring element starting locations. Three 2"x2" tape squares should be placed on the tiles between the corners or Crater as shown below. The two outer tape marks should align with the inside of the SoftTile seam. The third tape mark should be located in the center of the tile. If you were to draw an imaginary line through the three squares, that line would be parallel to the front faces of the lander. Each square should measure 14.5" from corner to corner as shown below.

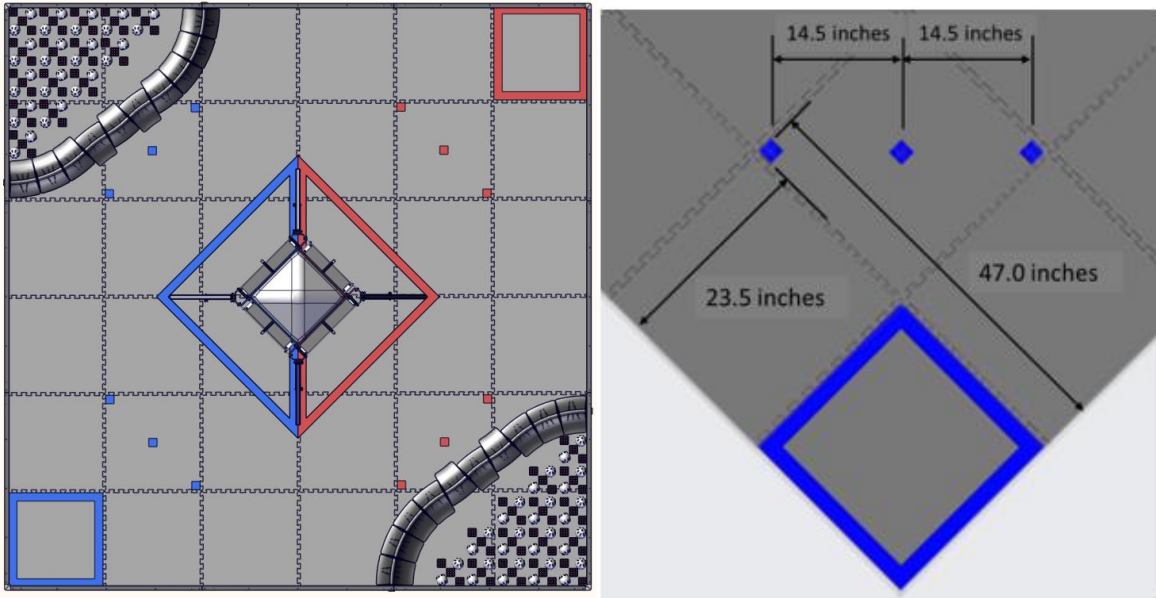

**Step 7-4: Taping the Alliance Stations:**

Use 2" RED and BLUE Gaffers Tape to mark the edges of the Alliance Stations on the floor outside the playing field as shown below. The RED alliance station should be on the right side when viewed from the audience. The BLUE alliance station should be on the left side when viewed from the audience.

Each alliance station is a 42" x 144" rectangle measured from the outside of the tape. The front edge of the Alliance Station should be approximately 18" away from the field perimeter. The sides of the Alliance Station box should line up with the front and back edges of the field perimeter.

In the center on the front edge of each alliance station, a 2'x2' Scoring Referee Station should be taped off as well.

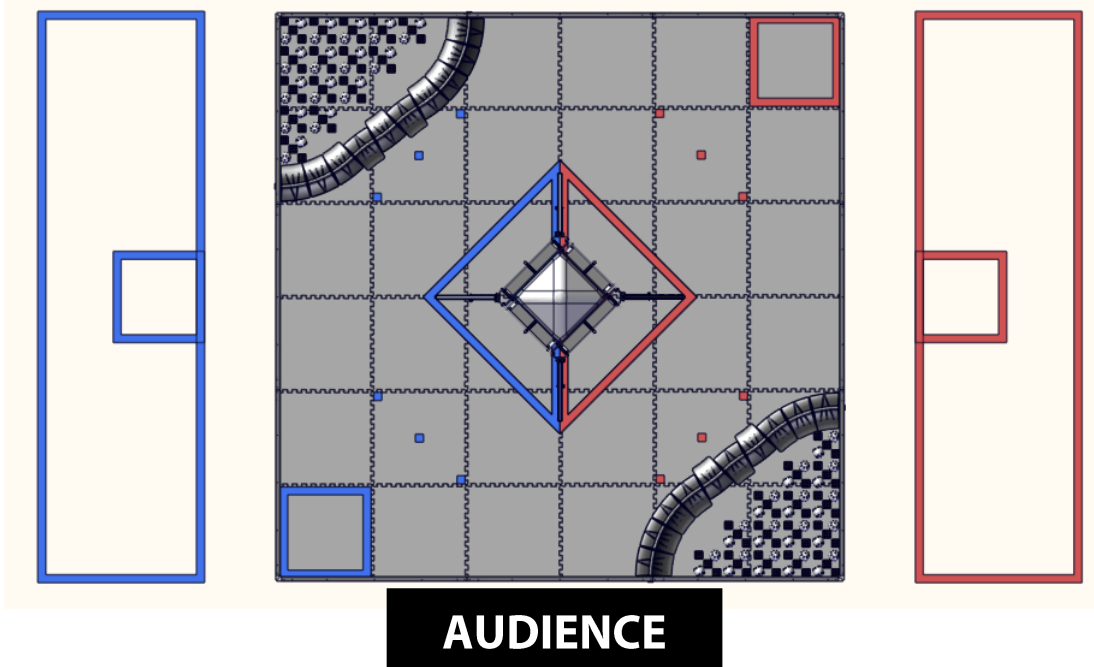

### **Step 7-5: Referee Question Box**

The Referee Question Box is a place where Teams can ask questions of the Referees after a Match.

The Referee Question Box must be placed in the Competition Area in a location where it will not interfere with the current running Matches, but close enough that the Referees will be able to see a student waiting at the Question Box. The Question Box can be as simple as a 3ft Gaffers Tape square on the floor.

