

# Magnetic Encoder Kit User's Guide

Revision 1.5



Cross The Road Electronics

[www.ctr-electronics.com](http://www.ctr-electronics.com)

## Table of Contents

1. Device description .....	5
1.1. Kit Contents.....	5
1.2. Features .....	5
1.3. Pin Descriptions .....	6
1.4. Electrical Specifications.....	7
1.4.1. Quadrature Decoding Types.....	7
1.5. Magnet Specification .....	8
1.6. LED States .....	8
2. Installation .....	9
2.1. Magnet Placement.....	9
Magnet Placement (cont.) .....	10
2.2. Encoder Mounting .....	10
2.3. Confirming Proper Installation.....	10
3. Modifications to COTS Components .....	11
3.1. AndyMark Toughbox Mini (am-0654).....	11
3.1.1. Extrusion removal .....	11
3.1.2. Facing Off the Shaft End.....	12
3.1.3. Boring the Magnet Pocket.....	13
3.1.4. Mounting the Encoder .....	14
3.1.5. Verifying Magnet Placement.....	15
3.2. VEX PRO Single Speed Double Reduction Gearbox (217-2454) .....	16
3.2.1. Extrusion removal .....	16
3.2.2. Facing Off The Shaft End .....	17
3.2.3. Boring the Magnet Pocket.....	18
3.2.4. Mounting the Encoder .....	19
3.2.5. Verifying Magnet Placement.....	20
4. Limit Switch Connections.....	21
4.1. Tin the Solder Pads.....	21
4.2. Solder Leads to Pads .....	22
4.3. Route the leads through the Housing .....	22
5. FAQ .....	23
5.1. Is there a way to tell if the sensor is present/powerd?.....	23
5.2. Where can we get more data cables? Lengths?.....	23
5.3. Is the sensor Quadrature or not? I'm not sure what's best for my application. ....	23
5.3.1. Measuring Velocity.....	23

5.3.2. Measuring Position..... 24

5.4. Can I use the CTRE Magnetic Encoder without a Talon SRX? ..... 24

5.4.1. FRC2016: Leveraging the available Product Donation Vouchers..... 24

5.4.2. Ribbon Cable Breakout..... 24

6. Mechanical Drawings..... 25

7. VersaPlanetary Integrated Encoder ..... 26

8. Revision History ..... 27

**TO OUR VALUED CUSTOMERS**

It is our intention to provide our valued customers with the best documentation possible to ensure successful use of your CTRE products. To this end, we will continue to improve our publications, examples, and support to better suit your needs.

If you have any questions or comments regarding this document, or any CTRE product, please contact [support@crosstheroadelectronics.com](mailto:support@crosstheroadelectronics.com)

To obtain the most recent version of this document, please visit [www.ctr-electronics.com](http://www.ctr-electronics.com).

# 1. Device description

The CTR Magnetic Encoder is a rotary sensor that can be used to measure rotational position and velocity. The device senses the magnetic field of a diametrically polarized magnet to determine rotational position with 12 bit precision. The device provides both a Quadrature interface that may be used for relative position measurement and a Pulse Width Modulated output for absolute position measurement. The device connects directly to the Talon SRX data port and is directly supported in the Talon's firmware.

## 1.1. Kit Contents

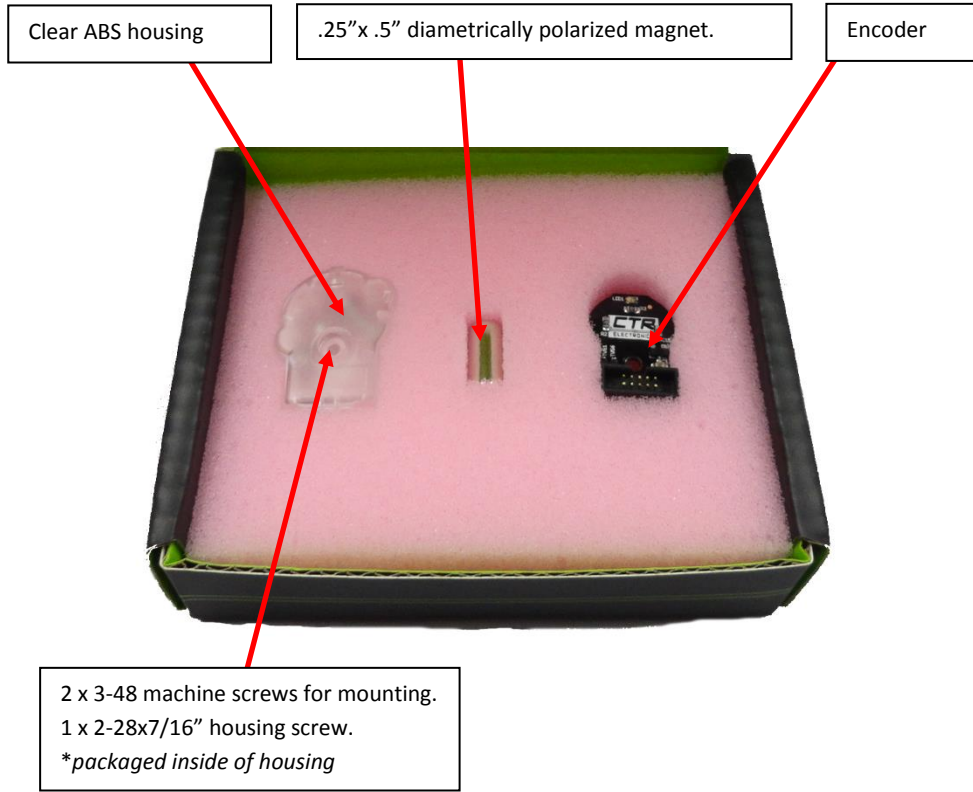

## 1.2. Features

- Tri-color LED indicator for magnetic field strength
- Conformal coating helps protect against foreign body debris (FOD)
- Built in ESD protection diodes
- Outputs both Quadrature AND Pulse Width Modulated signals simultaneously for both absolute and relative positioning.
- Connects directly to Talon SRX without the need for custom cables
- Limit switch support
- Supported by Talon SRX firmware

### 1.3. Pin Descriptions

The Magnetic Encoder has a 10 pin connector that mates to the Talon SRX through a ribbon cable (sold separately). The table below contains the pin descriptions and numbering for users who wish to connect the encoder to other devices.

Pin number	Name	Function
1	3.3V	3.3 volt supply ( not used)
2	5V	5 volt supply (externally sourced)
3	NC	Not connected
4	FLMT	Forward limit switch input
5	B	Quadrature channel B output
6	NC	Not connected
7	A	Quadrature channel A output
8	RLMT	Reverse limit switch input
9	PWM	Pulse Width Modulated output
10	GND	Device power ground

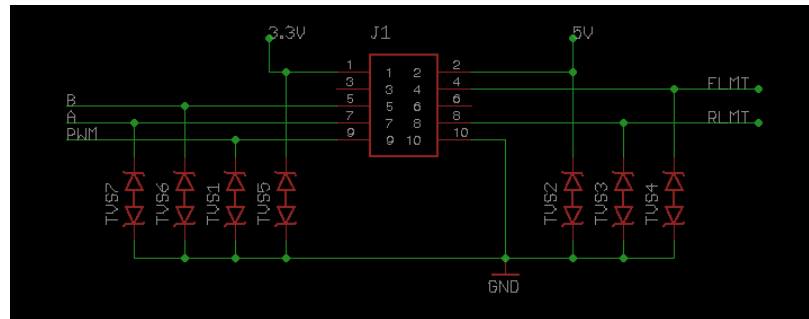

## 1.4. Electrical Specifications

Symbol	Parameter	Condition	Min	Typ	Max	Unit
Tamb	Ambient temperature		-40		+150	°C
I <sub>supp</sub>	Supply Current	DC supply voltage 5.0V	17	19	31	mA
V <sub>dd</sub>	Supply voltage		3.75	5.0	6.0	V
<b>Quadrature Outputs (A and B)</b>						
V <sub>oL</sub>	Low level output voltage				GND+0.4	V
V <sub>oH</sub>	High level output voltage		2.8	3.3		V
I <sub>o</sub>	Output current				2	mA
V <sub>max</sub>	Rotational velocity				15000	RPM
<b>PWM Output</b>						
V <sub>oL</sub>	Low level output voltage				GND+0.4	V
V <sub>oH</sub>	High level output voltage		2.8	3.3		V
I <sub>o</sub>	Output current				2	mA
V <sub>max</sub>	Rotational velocity				6600	RPM
f <sub>PWM</sub>	PWM frequency		220	244	268	Hz
PW <sub>MIN</sub>	Minimum pulse width		0.90	1	1.10	us
PW <sub>MAX</sub>	Maximum pulse width		3686	4096	4506	us
<b>ESD Rating</b>						
	ESD Protection Contact Discharge				±30	kV
	ESD Protection Air-Gap Discharge				±30	kV
<b>Resolution</b>						
CPR	Counts per revolution	1 X decoding		1024		CPR
CPR	Counts per revolution	4 X decoding <sup>(1)</sup>		4096		CPR

Note 1: Talon SRX and CANifier decode 4X only

### 1.4.1. Quadrature Decoding Types

Quadrature decoding is accomplished by detecting the edges of both the A and B channels of the Encoder. The encoding type is determined by the number of edges counted for one encoder cycle (not rotation). A complete cycle consists of 4 edges, 2 rising edges and 2 falling edges. An encoding type of 1x only counts 1 of these 4 edges, 2x encoding would count 2 edges and 4 x encoding would count all 4. The Talon SRX and CANifier always uses 4x decoding and therefore always decodes a total of 4096 CPR (counts per revolution).

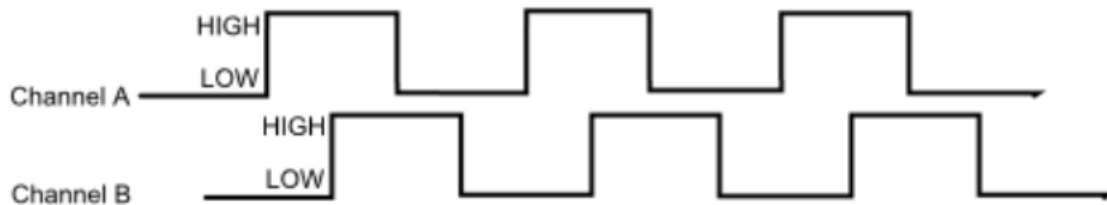

## 1.5. Magnet Specification

Parameter	Condition	Value	Unit
Length	$\pm 0.004$	.500	INCH
Diameter	$\pm 0.004$	.250	INCH
Material	Grade N42	NdFeB	
Plating		Nickel	
Magnetization Direction		Diametrical	
Weight		.106	OUNCE
Surface Field		6898	GAUSS
Max Operating Temperature		176°	F
$B_{r_{max}}$ (Residual Induction)		13200	GAUSS
$BH_{max}$ (Maximum Energy Product)		42	MGOe

## 1.6. LED States

The Encoder features a tri color LED that indicates magnetic field strength. This feature can be used to confirm proper magnet distancing. The table below shows the possible color states and their respective magnetic field strength.

Color	Condition	Description
<b>Off</b>	Magnetic Encoder is not powered/ plugged in.	Check cabling to the Magnetic Encoder and check that Talon is powered.
<b>Red</b>	Magnet is out of range	Magnetic field strength is $<25\text{mT}$ or $>135\text{mT}$
<b>Yellow</b>	Magnet in range (slightly reduced accuracy)	Magnetic field strength is between $25\text{-}45\text{mT}$ or $75\text{-}135\text{mT}$
<b>Green</b>	Magnet in Range (ideal)	Magnetic field strength is between $45\text{mT} - 75\text{mT}$



## 2. Installation

Proper alignment of the magnet, rotary shaft and encoder is necessary to ensure reliable performance. The magnet should be placed at the end of a rotary shaft so that the magnet, shaft and encoder are coaxial. The encoder will tolerate some eccentricity, however steps should be taken to ensure that the magnet is concentric to the shaft and encoder. If a nonferrous shaft is used it is recommended that an adhesive is used to keep the magnet from rotating inside the rotary shaft. A press fit may be used to avoid this, however the magnet material is brittle and can be damaged if a tight press fit is required.

### 2.1. Magnet Placement

The typical distance "Z" between the magnet and the housing detent, as illustrated in Figure 2.1, is .75mm (.030") to 1.5mm (.059"). The table below shows the relationship between LED color and magnet Z distance.

LED color	Minimum distance from detent	Maximum distance from detent "Z"
Red	NA	>2.95mm (.116")
Yellow	0.0mm	2.95mm (.116")
Green	.75mm (.030")	1.5mm (.059")

This table assumes the use of supplied magnet. If a different magnet is used, the LED may be used to determine correct distancing.

Figure 2.1.

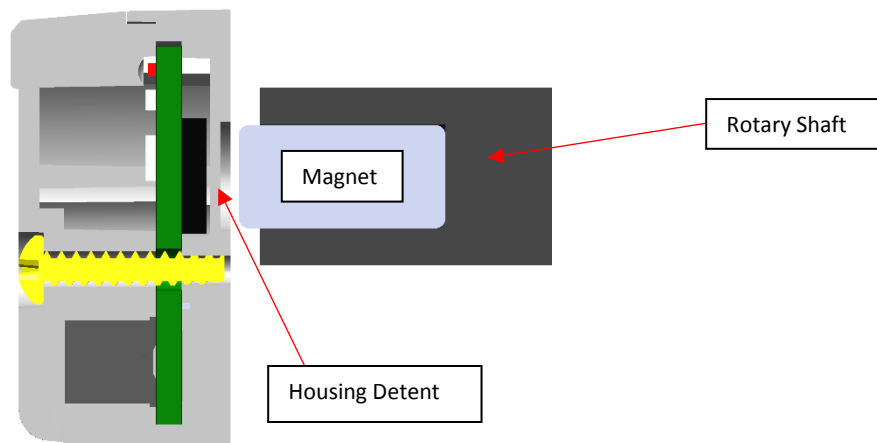

## Magnet Placement (cont.)

The magnet's center axis must be aligned within an offset radius  $R_d$  of 0.25mm (.009") from the defined center of the encoder housing, see Figure 2.2. This is the recommendation from the silicon manufacturer. The ideal application would have the magnet, rotary shaft and encoder all coaxial. However, the encoder will function without any noticeable performance loss if this tolerance cannot be held.

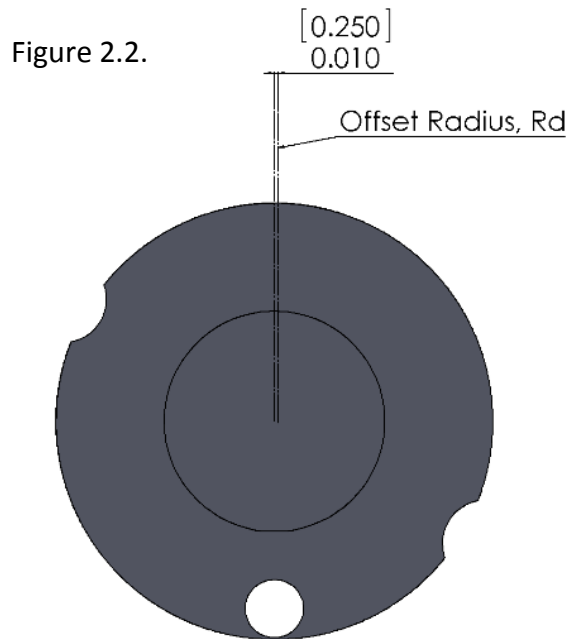

## 2.2. Encoder Mounting

The encoder should be mounted to a surface that is rigid and in a fixed position relative to the magnet and rotary shaft. A center hole is not required provided the material the encoder is mounted to has a relative magnetic permeability similar to air ( $\sim 1.0$ ). Aluminum and most plastics meet this requirement.

## 2.3. Confirming Proper Installation

When properly installed, the LED should be **green**. A **yellow** LED is acceptable however there is less tolerance to mechanical deviation that may cause the Z distance to change, as this state is farther away from ideal. The LED should remain **green** through the shafts full range of motion and speed. If the LED transitions or “blips” a color other than **green**, confirm that the mechanical relationship between the encoder, shaft and magnet are consistent. This can be done through manual movement of the components until the cause is isolated. Determine whether the problem is shaft end play, encoder mounting or magnet installation.

## 3. Modifications to COTS Components

There are several companies that make commercial off the shelf, or COTS, transmissions and gear boxes. Some of these components contain interfaces for optical or shaft type encoders. This section describes modifications of two COTS transmissions, the AndyMark Toughbox Mini (am-0654) and the VEX PRO Single Speed Double Reduction gearbox (217-2454). Both gearboxes require modification to the output shaft.

### 3.1. AndyMark Toughbox Mini (am-0654)

The output shaft of the Toughbox Mini features a .250" diameter extrusion located at the housing side of the gearbox Figure 3.1. This extrusion needs to be removed before boring the pocket that will house the magnet. The recommended tools for this procedure are: lathe, .250" drill bit, dial calipers, parting tooling and a cutting tool for facing off the end of the shaft. A hacksaw or cutoff wheel may be used in place of the parting tool. This user manual is not intended to be a substitute for proper training and use of machinery. **A lathe can be the most dangerous piece of machinery in a shop. Please exercise caution and follow recommended safety procedures for your particular piece of equipment.** The shaft pictured is from a CIMple box. The procedure for both the Toughbox Mini and CIMple box are the same.

Figure 3.1.

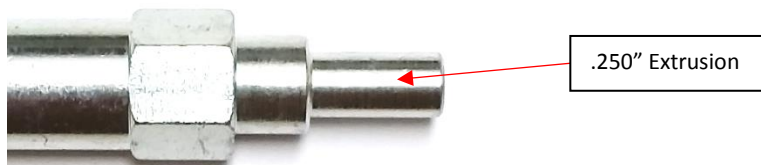

#### 3.1.1. Extrusion removal

The first step is to remove the .250" extrusion from the output shaft. Figure 3.1.1 illustrates how a parting tool and a lathe can be used for this task. Completely remove the extrusion so that only a small portion of the .250" diameter is remaining (about ~.020" - .050").

Figure 3.1.1.



### 3.1.2. Facing Off the Shaft End

Once the Extrusion has been removed, the end of the shaft will need to have a smooth even surface. This will make the following steps go smoother. Using a facing tool, turn the face of the shaft down until it is smooth and all of the remaining .250" extrusion is removed. Figure 3.1.2.1 illustrates the tooling used for this step. Figure 3.1.2.2 shows what the shaft should look like after this step has been completed.

Figure 3.1.2.1.



Figure 3.1.2.2.



### 3.1.3. Boring the Magnet Pocket

After the shaft has been faced, a pocket will need to be bored to house the magnet. The depth of this pocket is determined by the distance the encoder is located from the magnet. For the stock mounting location the pocket should be deep enough so the magnet is flush with the outside of the plastic housing after assembly. A bore depth of  $\sim .350''$  should be sufficient. This of course is dependent on how much material was removed during step 3.1.2. A centering drill should be used to start the hole prior to boring with a  $.250''$  drill. If the hole is bored too deep, shims may be placed inside the pocket to correct the over bore. The goal is to make the final seated depth of the magnet so that the face is flush with the encoder housing (not the detent). Figure 3.1.3.1 shows the final hole being bored with a  $.250''$  drill. Figure 3.1.3.2 shows the output shaft with all the necessary modifications and magnet installed.

Figure 3.1.3.1.



Figure 3.1.3.2.



### 3.1.4. Mounting the Encoder

After the shaft has been completely modified, the encoder housing should be mounted using the two supplied 3-48 machine screws (Figure 3.1.4.1). Next place the encoder inside the housing (Figure 3.1.4.2). Insert the data cable (sold separately) then place the housing cover and secure it with the supplied 2-28 x 7/16" screw (Figure 3.1.4.3). **DO NOT OVER TIGHTEN THE 2-28 SCREW AS THIS MAY RESULT IN PERMANENT DAMAGE TO THE HOUSING. HAND TIGHTEN UNTIL RESISTANCE IS FELT.**

Figure 3.1.4.1.



Figure 3.1.4.2.

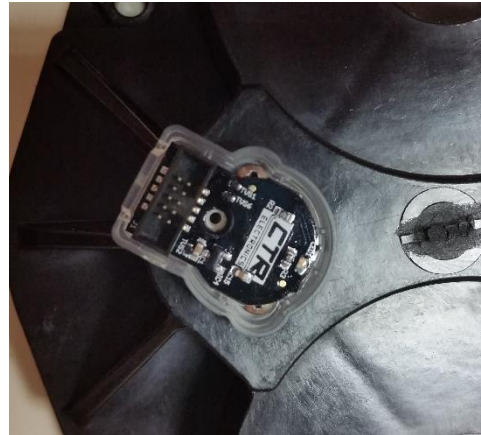

Figure 3.1.4.3.





### 3.1.5. Verifying Magnet Placement.

Once the Encoder has been installed, magnet placement should be verified. A properly distanced magnet should result in a **green** LED at all speeds and positions. To confirm placement, simply connect the data cable to a Talon SRX or any Gadgeteer port on the HERO Control System (Figure 3.1.5). This test only requires the Talon or HERO to be powered. No software is needed. Verify the LED is **green**. If the LED is **yellow** the encoder will still perform with a small reduction in accuracy. If the LED is **red**, the magnet is either too close or too far away from the encoder. Using the supplied magnet, the LED should only be **red** if the magnet is too far away. This is only true when the encoder is mounted in its supplied housing. Increase or decrease the magnet distance until the LED is **green**. Once magnet position is confirmed, the magnet should be secured using Loctite or epoxy. Loctite/Epoxy is usually not necessary for steel shafts.

Figure 3.1.5.



### 3.2. VEX PRO Single Speed Double Reduction Gearbox (217-2454)

The output shaft of the VEX pro Gearbox has a .250" diameter extrusion located at the housing side of the gearbox Figure 3.2. This extrusion needs to be removed before boring the pocket that will house the magnet. The recommended tools for this procedure are: lathe, .250" drill bit, dial calipers, parting tooling and a cutting tool for facing off the end of the shaft. A hacksaw or cutoff wheel may be used in place of the parting tool. This user manual is not intended to be a substitute for proper training and use of machinery. **A lathe can be the most dangerous piece of machinery in a shop. Please exercise caution and follow recommended safety procedures for your particular piece of equipment.**

Figure 3.2.

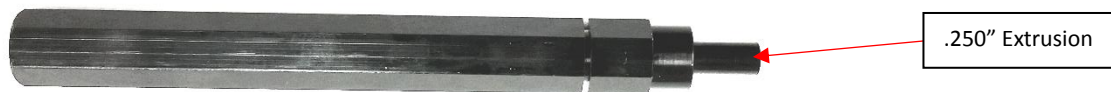

#### 3.2.1. Extrusion removal

The first step is to remove the .250" extrusion from the output shaft. Figure 3.2.1 illustrates how a parting tool and a lathe can be used for this task. Completely remove the extrusion so that only a small portion of the .250" diameter is remaining (about  $\sim .020'' - .050''$ ).

Figure 3.2.1.

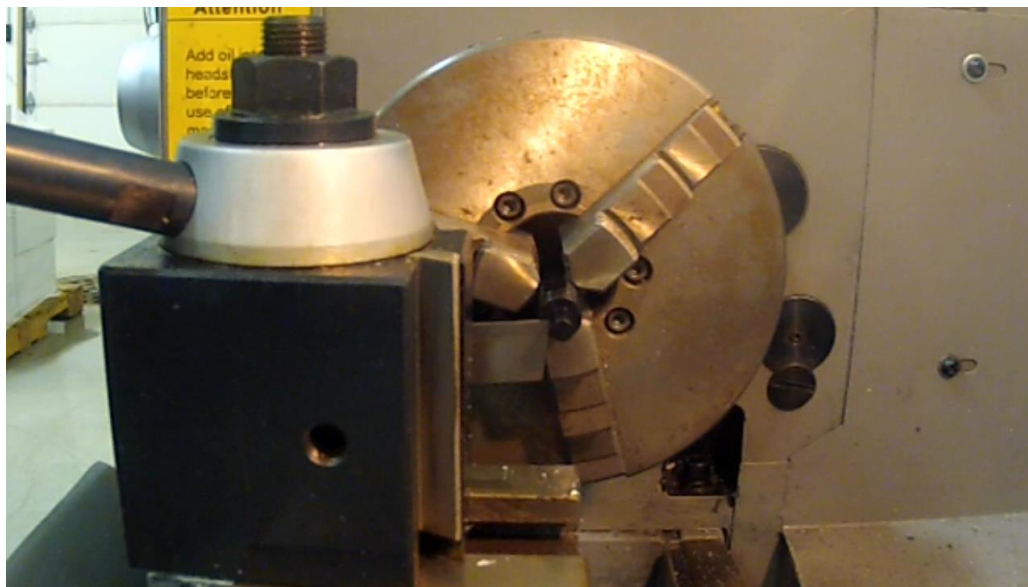



### 3.2.2. Facing Off The Shaft End

Once the Extrusion has been removed, the end of the shaft will need to have a smooth even surface. This will make the following steps go smoother. Using a facing tool, turn the face of the shaft down until it is smooth and all of the remaining .250" extrusion is removed. Figure 3.2.2.1 illustrates the tooling used for this step. Figure 3.2.2.2 show's what the shaft should look like after this step has been completed.

Figure 3.2.2.1

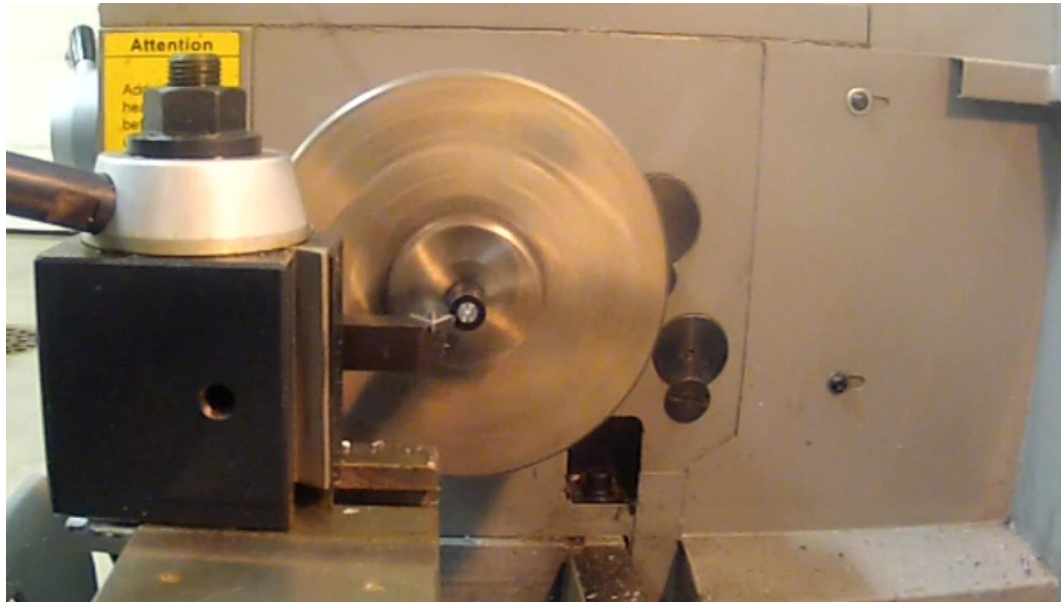

Figure 3.2.2.2



### 3.2.3. Boring the Magnet Pocket

After the shaft has been faced, a pocket will need to be bored to house the magnet. The depth of this pocket is determined by the distance the encoder is located from the magnet. For the stock mounting location the pocket should be deep enough so the magnet is flush with the outside of the gearbox plastic housing after assembly. A bore depth of  $\sim .380''$  should be sufficient. This of course is dependent on how much material was removed during step 3.2.2. A centering drill should be used to start the hole prior to boring with a  $.250''$  drill. If the hole is bored too deep, shims may be placed inside the pocket to correct the over bore. The goal is to make the final seated depth of the magnet so that the face is flush with the encoder housing (not the detent). Figure 3.2.3.1 shows the final hole being bored with a  $.250''$  drill. Figure 3.2.3.2 shows the output shaft with all the necessary modifications and magnet installed.

Figure 3.2.3.1



Figure 3.2.3.2

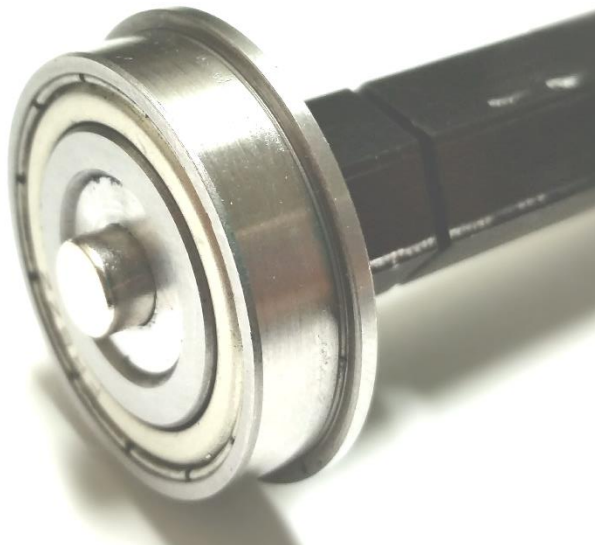

### 3.2.4. Mounting the Encoder

After the shaft has been completely modified, the encoder housing should be mounted using the two supplied 3-48 machine screws (Figure 3.2.4.1). Next place the encoder inside the housing (Figure 3.2.4.2). Insert the data cable (sold separately) then place the housing cover and secure it with the supplied 2-28 x 7/16" screw (Figure 3.2.4.3). **DO NOT OVER TIGHTEN THE 2-28 SCREW AS THIS MAY RESULT IN PERMANENT DAMAGE TO THE HOUSING. HAND TIGHTEN UNTIL RESISTANCE IS FELT.**

Figure 3.2.4.1

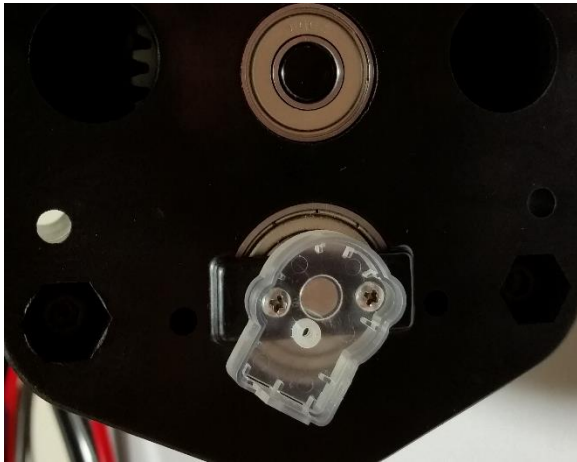

Figure 3.2.4.2

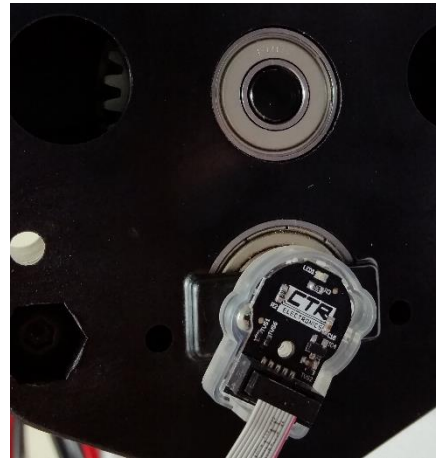
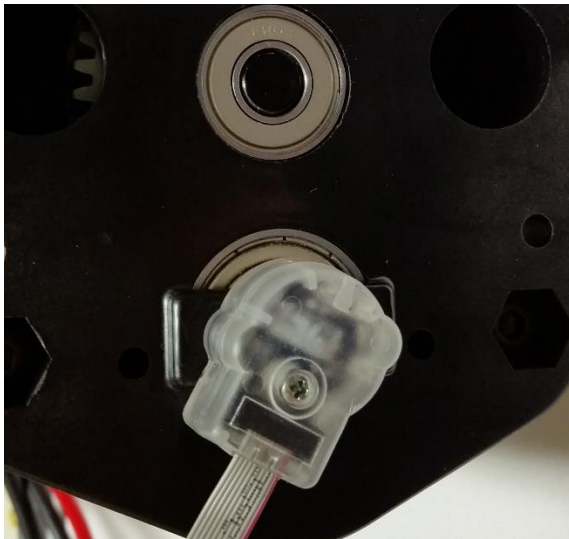

Figure 3.2.4.3



### 3.2.5. Verifying Magnet Placement.

Once the Encoder has been installed, magnet placement should be verified. A properly distanced magnet should result in a **green** LED at all speeds and positions. To confirm placement, simply connect the data cable to a Talon SRX (Figure 3.2.5.1) or any Gadgeteer port on the HERO Control System (Figure 3.2.5.2). This test only requires the Talon or HERO to be powered. No software is needed. Verify the LED is **green**. If the LED is **yellow** the encoder will still perform with a small reduction in accuracy. If the LED is **red**, the magnet is either too close or too far away from the encoder. Using the supplied magnet the LED should only be **red** if the magnet is too far away. This is only true when the encoder is mounted in its supplied housing. Increase or decrease the magnet distance until the LED is **green**. Once magnet position is confirmed, the magnet should be secured using Loctite or epoxy.

Figure 3.2.5.1

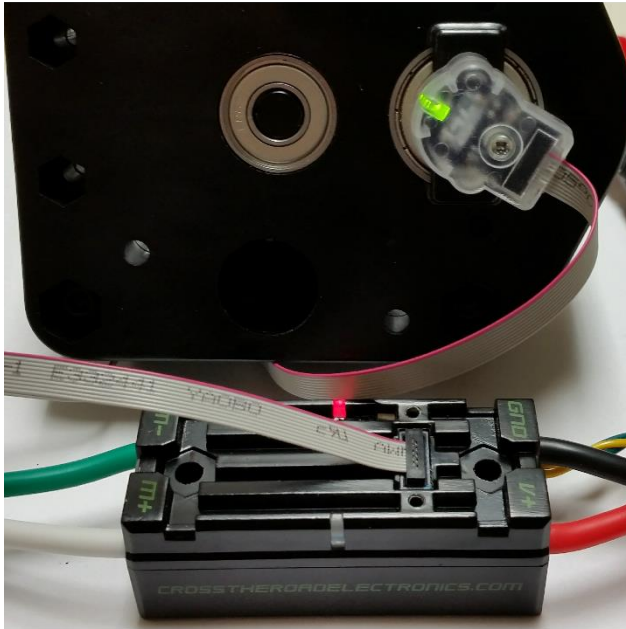
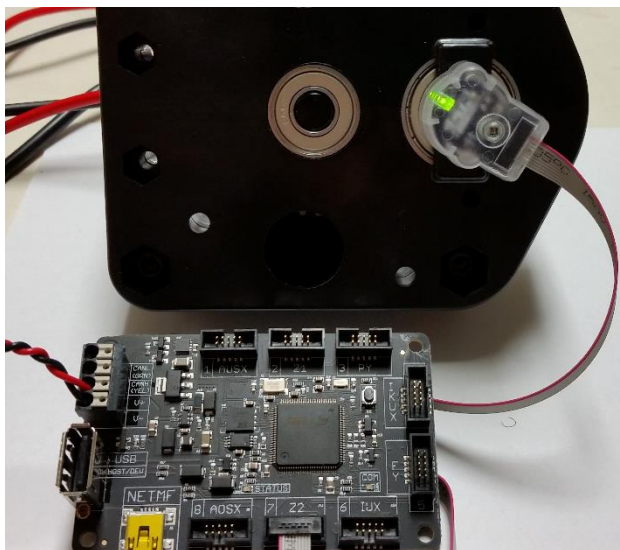

Figure 3.2.5.2: Interfacing to a Hero





## 4. Limit Switch Connections

Located on the back of the encoder are 4 solder pads. These pads expose the limit switch connections of the Talon SRX. Leads will need to be soldered to these pads in order to interface with the limit switches. After the leads have been soldered to the encoder PCB they will need to be routed through the bottom half of the housing

### 4.1. Tin the Solder Pads

Locate the four pads on the bottom side of the encoder PCB (Figure 4.1). Tin the pads using a solder of your choice.

Figure 4.1.

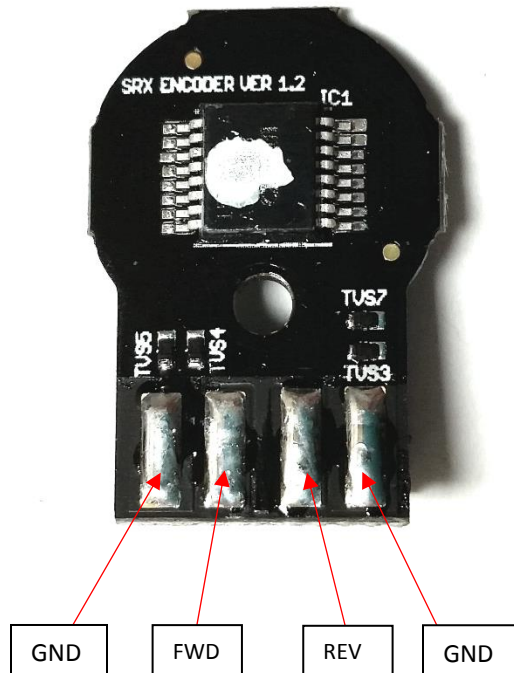

## 4.2. Solder Leads to Pads

After the pads have been tinned, solder the leads (up to 20 gauge wire) to the pads. Be careful to not disturb the Transient voltage suppressors that are located near the pads. If you disturb the TVS diodes the encoder will still function but will lose some of its protection against electro-static discharge (ESD).

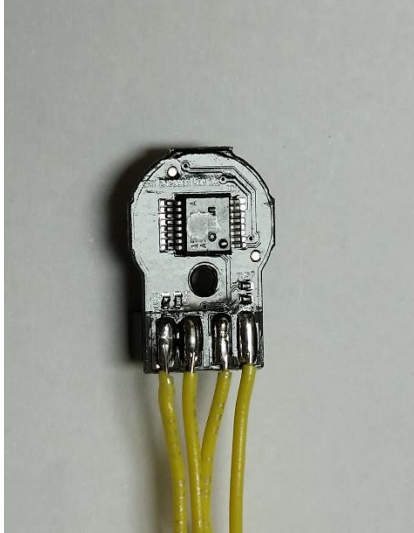

## 4.3. Route the leads through the Housing

Once the leads are soldered in place, route each pair through the holes located at the bottom of the housing. Once this step is complete, the limit switches may be connected to the leads.

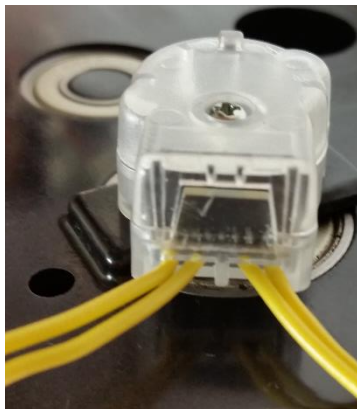

## 5. FAQ

### 5.1. Is there a way to tell if the sensor is present/powered?

To determine visually if the sensor is powered and functioning, check the built-in LED, see [Section 1.6](#).

To determine programmatically if the sensor is powered, application can check if pulse widths are being received. Regardless of the position and velocity, the Magnetic Encoder will always provide pulse width events, which can be used to programmatically determine if the sensor has become unplugged.

### 5.2. Where can we get more data cables? Lengths?

Cabling options will be available at [ctr-electronics.com](http://ctr-electronics.com).

### 5.3. Is the sensor Quadrature or not? I'm not sure what's best for my application.

The Magnetic Encoder provides two signals simultaneously, Pulse Width Modulated and Quadrature. Minimally, the sensor can be used as a generic 1024CPR Quadrature Encoder on any hardware platform that supports decoding Quadrature (A/B).

Quadrature is beneficial because...

- It is a common interface for encoding position without loss-of-accuracy (an advantage over analog).
- Does not require handshaking or a software driver (an advantage over SPI/I2C/serial).
- The encoding/decoding is very fast. Changes in position are encoded as single digital edges, and typically decoding is done in hardware with no software decoder latency.

However the drawback to Quadrature is that the encoded position is relative to the sensor's mechanical position during boot-up. This means that mechanisms that require absolute positioning may require teams to...

- Ensure mechanisms are in the same orientation every time the robot boots. This can be cumbersome when developing/testing software or during competition.
- Add sensors (such as limit switches) to detect when the sensor reaches a fixed position. This creates additional failure points in the robot.
- Use an index signal, which requires driving the mechanism in an open-loop fashion until index edge is detected.

The Magnetic Encoder solves this cleanly by also providing a Pulse Width Modulated signal that represents the absolute magnet position. The Pulse Width signal is updated every ~4ms (see specification) which is slower than the edge-event decoding of the Quadrature interface. So when using the Pulse Width signal, the maximum RPM the sensor can track is reduced (see Table 5.3.1).

However because the Magnetic Encoder provides both interfaces simultaneously, and because the Talon SRX decodes both simultaneously, the application is free to choose the best-fit solution with no effort, or get the best of both sensors with minimal effort.

#### 5.3.1. Measuring Velocity

Peak Velocity	Quad	Pulse Width	Notes
<6600RPM	X	X	The 4ms update rate of the Pulse Width signal will not impact the ability to measure the velocity of the magnet. Additionally the user may choose to sample both interfaces to ensure good-cable-health.
>=6600RPM	X		The 4ms update rate of the Pulse Width signal may impact the ability to measure velocity, therefore using the faster Quadrature interface is recommended.

### 5.3.2. Measuring Position

Signal Type	Signal Transmission Latency	Absolute?	Notes
Pulse Width	Up-to-4ms (Pulse width rise ranges from 1us to ~4ms.)	Y	Position can be measured with both interfaces, however the Pulse Width signal will have an up-to-4ms latency since the Pulse Width has to complete to be decoded.
Quad	Negligible because Quad is an edge-driven encoding.	N	
Seed Quad with Pulse Width	Negligible because Quad is an edge-driven encoding.	Y	A simple solution to achieve the best of both sensors is to... [1] Sample the Pulse Width position when system is at rest [2] Set the position of the Quadrature signal to match it. This will effectively make the Quadrature signal an absolute signal.

### 5.4. Can I use the CTRE Magnetic Encoder without a Talon SRX?

The Magnetic Encoder provides a 1024 CPR Quadrature signal that can be decoded by any system that support Quadrature. However Quadrature is a relative-position signal. In order to determine absolute position (within one rotation) the pulse width signal must also be decoded.

 This includes the roboRIO FRC Control System.

#### 5.4.1. FRC2016: Leveraging the available Product Donation Vouchers

 If you haven't already, leverage the VEX/CTRE voucher for **2 free Talon SRXs**. This also means leveraging the closed-loop features of the Talon since the Talon directly supports this sensor (absolute and relative). You can also read the sensor data from the roboRIO over CAN Bus (even while using the closed-loop features) for roboRIO-side processing.

<http://www.vexrobotics.com/pdv-2016.html>

#### 5.4.2. Ribbon Cable Breakout

A breakout can be used to adapt the ribbon cable interface to a custom wires.

An example of this is to repurpose the Encoder Breakout (<http://www.ctr-electronics.com/talon-srx-encoder-breakout-board.html>) to adapt the ribbon cable to solder pads.

This breakout is small enough to be wrapped in heat-shrink tubing and provides labeled solder pads for Quadrature, Power, and Limit Switches. This breakout also provides additional ESD protection. Use the 5V pad for powering the Magnetic Encoder.

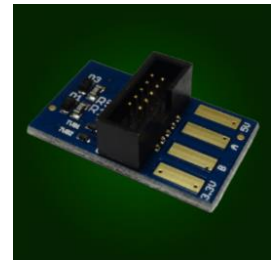

There are many breakout solutions available that can be used to adapt the ribbon cable in a variety of ways. See [Section 1.3](#) for pin descriptions.

Section 1.4.3 in the Talon's SRX User's Guide also has pinout wiring for a quadrature sensor. Connect the limit switch signals as well if the Magnetic Encoder's limit switch pads are to be used.

This example breakout can be found at <http://www.ctr-electronics.com/breakoutmodule.html>



## 6. Mechanical Drawings

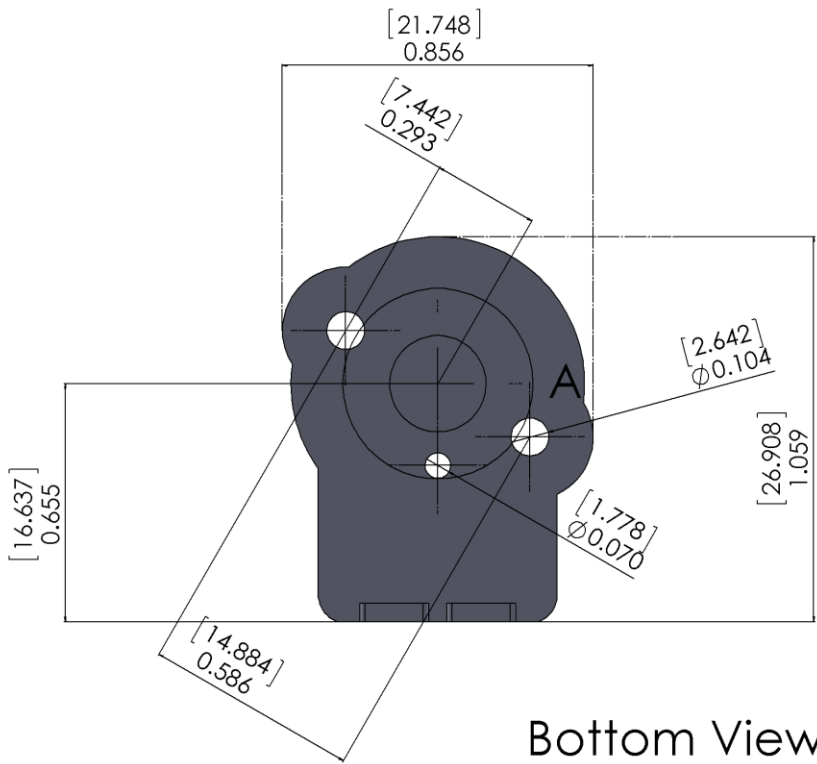

Bottom View

## 7. VersaPlanetary Integrated Encoder



The VEXpro VersaPlanetary Integrated Encoder also leverages the CTRE Magnetic Encoder, giving FRC Teams and integrators another method of leveraging the sensor.

Simply insert this slice into your VersaPlanetary gearbox – No magnet installation is necessary.

The same cabling strategies are used to connect the encoder to your Talon SRX/quadrature-decoder.

In this use-case it is typical for the Magnetic Encoder LED to be **Yellow**.

## 8. Revision History

Revision	Date	Description
1.5	24-Jan-2018	Added section 1.4.1. Added CPR to electrical specs.
1.4	25-Jan-2016	Section 5.4 Added. Section 7 Added.
1.3	18-Dec-2015	Added ESD Rating. Spacing fix in Section 3.2.3.
1.2	19-Oct-2015	Various minor corrections.
1.1	15-Oct-2015	Description fix in Section 1.3. Typo fixed in Section 5.3.
1.0	14-Oct-2015	Initial Creation.