

REVISION HISTORY			
REV.	DESCRIPTION	DATE	DRAWN BY
1	ORIGINAL PRINT	10/31/2014	A. BAKER
2	DRAWN TO MEET AMDS-1	6/26/2018	A. SHORES
3	UPDATED TOLERANCES AND HOLE COUNT	5/26/2020	N. MASSOUDA

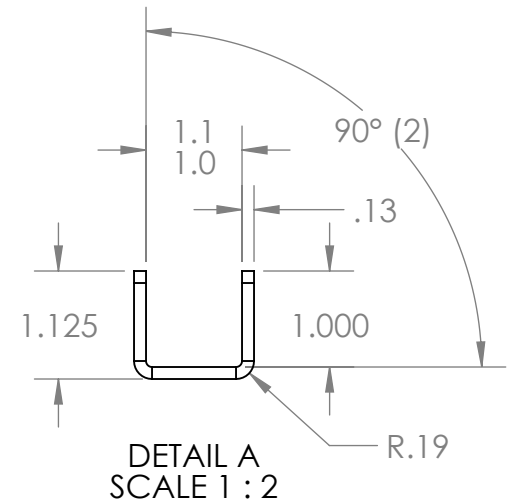

\*\*\* SEE CAD FOR ADDITIONAL TOOLPATH INFO\*\*\*

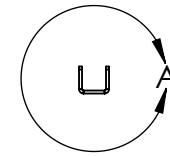
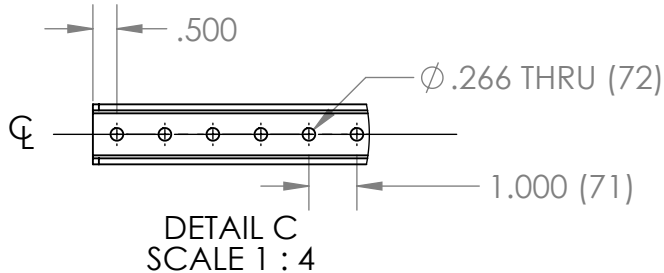
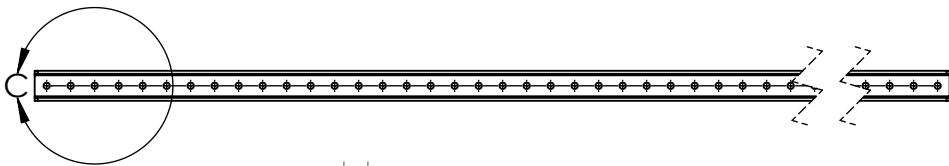
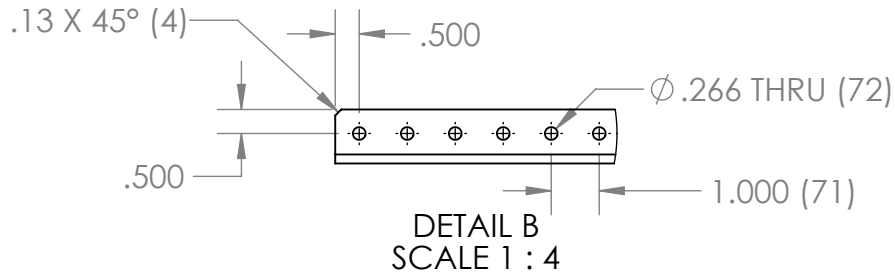
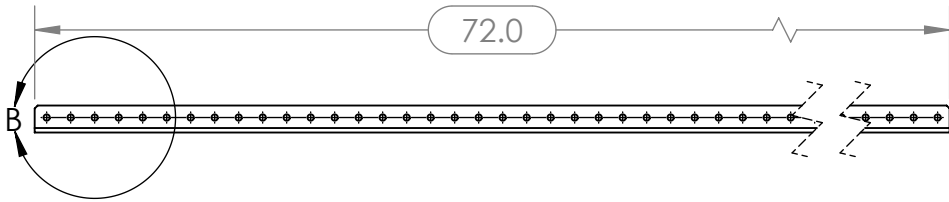
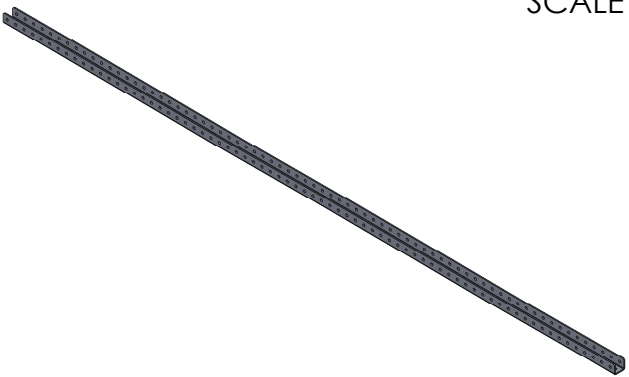

UNLESS OTHERWISE SPECIFIED:		COMMENTS:	
<b>DIMENSIONS ARE IN INCHES</b>		DUAL DIMENSIONS ARE IN MILLIMETERS.	
TOLERANCES:		BREAK ALL SHARP EDGES	
FRACTIONAL	±1/16		
ANGULAR: MACH	±1°		
ANGULAR: BEND	±5°		
ONE PLACE DECIMAL	±0.1		
TWO PLACE DECIMAL	±0.01		
THREE PLACE DECIMAL	±0.005		
FOUR PLACE DECIMAL	±0.0005		
MATERIAL	5052 ALUMINUM	NAME	DATE
FINISH	DEBURRED	CHECKED	NL 5/26/20
DO NOT SCALE DRAWING		ENG APPR.	
		MFG APPR.	
		Q.A.	



TITLE:			
C-CHANNEL 72IN			
SIZE	DWG. NO.	REV	
<b>A</b>	am-3052	<b>3</b>	
SCALE: 1:16		WEIGHT:	SHEET 1 OF 1