

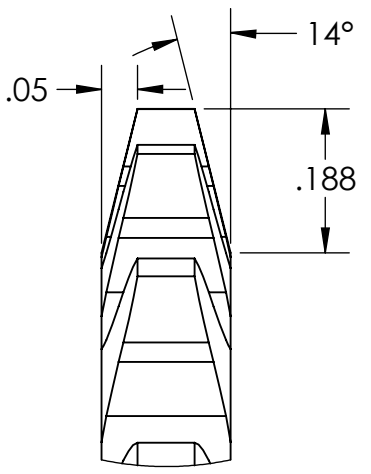

REVISION HISTORY			
REV.	DESCRIPTION	DATE	DRAWN BY
1	ORIGINAL PRINT	10/3/2008	A. BAKER
2	CHAMFER ADDED, UPDATED TO AMDS-1	7/16/2018	A. MILLS

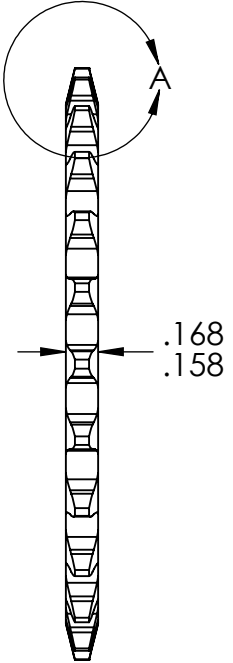
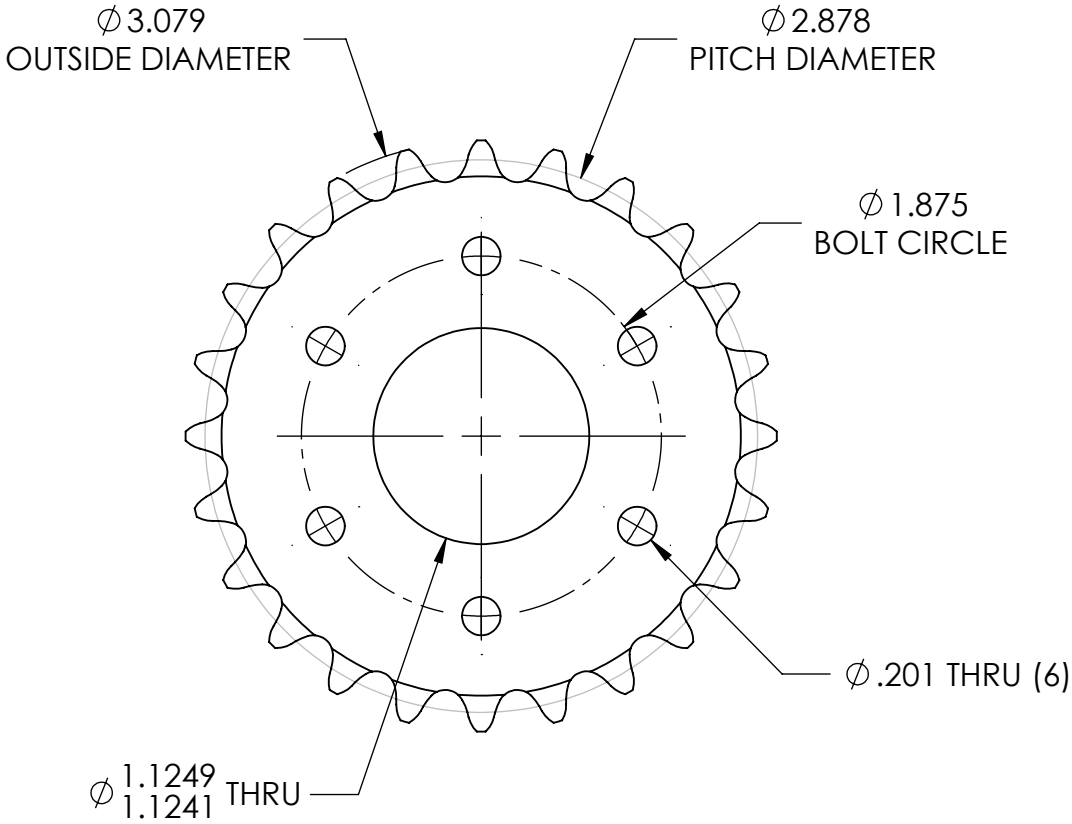

DETAIL A
SCALE 4 : 1

*** SEE CAD FOR ADDITIONAL TOOLPATH INFO***

UNLESS OTHERWISE SPECIFIED:		COMMENTS:					
DIMENSIONS ARE IN INCHES		DUAL DIMENSIONS ARE IN MILLIMETERS.					
TOLERANCES: FRACTIONAL ±1/16 ANGULAR: MACH ±1° ANGULAR: BEND ±5° ONE PLACE DECIMAL ±0.1 TWO PLACE DECIMAL ±0.01 THREE PLACE DECIMAL ±0.005 FOUR PLACE DECIMAL ±0.0005		BREAK ALL SHARP EDGES		TITLE: 24T 35 CHAIN BEARING BORE SPROCKET			
MATERIAL 6061-T6 ALUMINUM		CHECKED	NAME NM	DATE 7/16/18	SIZE A	DWG. NO. am-0217	REV 2
FINISH TUMBLER		ENG APPR.		MFG APPR.		SCALE: 1:1 WEIGHT: SHEET 1 OF 1	
DO NOT SCALE DRAWING		Q.A.					