

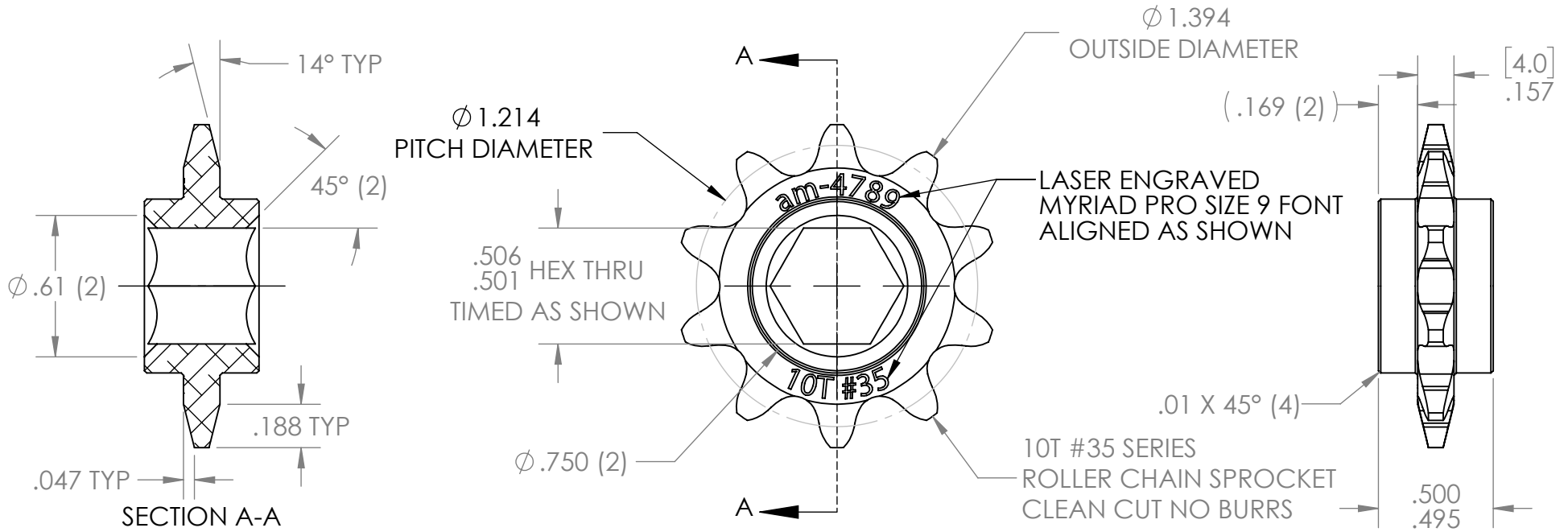

REVISION HISTORY			
REV.	DESCRIPTION	DATE	DRAWN BY
1	ORIGINAL PRINT	7/7/2022	T. JORGENSEN



*** SEE CAD FOR ADDITIONAL TOOLPATH INFO***

UNLESS OTHERWISE SPECIFIED:		COMMENTS:				
DIMENSIONS ARE IN INCHES		DUAL DIMENSIONS ARE IN MILLIMETERS.				
TOLERANCES:		BREAK ALL SHARP EDGES.		TITLE:		
FRACTIONAL	$\pm 1/16$			10T 35 CHAIN		
ANGULAR: MACH	$\pm 1^\circ$			500IN HEX BORE		
ANGULAR: BEND	$\pm 5^\circ$			SYMMETRICAL SPROCKET		
ONE PLACE DECIMAL	± 0.1			SIZE	DWG. NO.	REV
TWO PLACE DECIMAL	± 0.01			A	am-4789	1
THREE PLACE DECIMAL	± 0.005			SCALE: 1.5:1 SHEET 1 OF 1		
FOUR PLACE DECIMAL	± 0.0005					
MATERIAL	Cr 42 Mo	CHECKED	NAME	DATE		
FINISH	DEBURRED ZINC PLATED	ENG APPR.	NL	7/29/22		
DO NOT SCALE DRAWING		MFG APPR.				
		Q.A.				

