

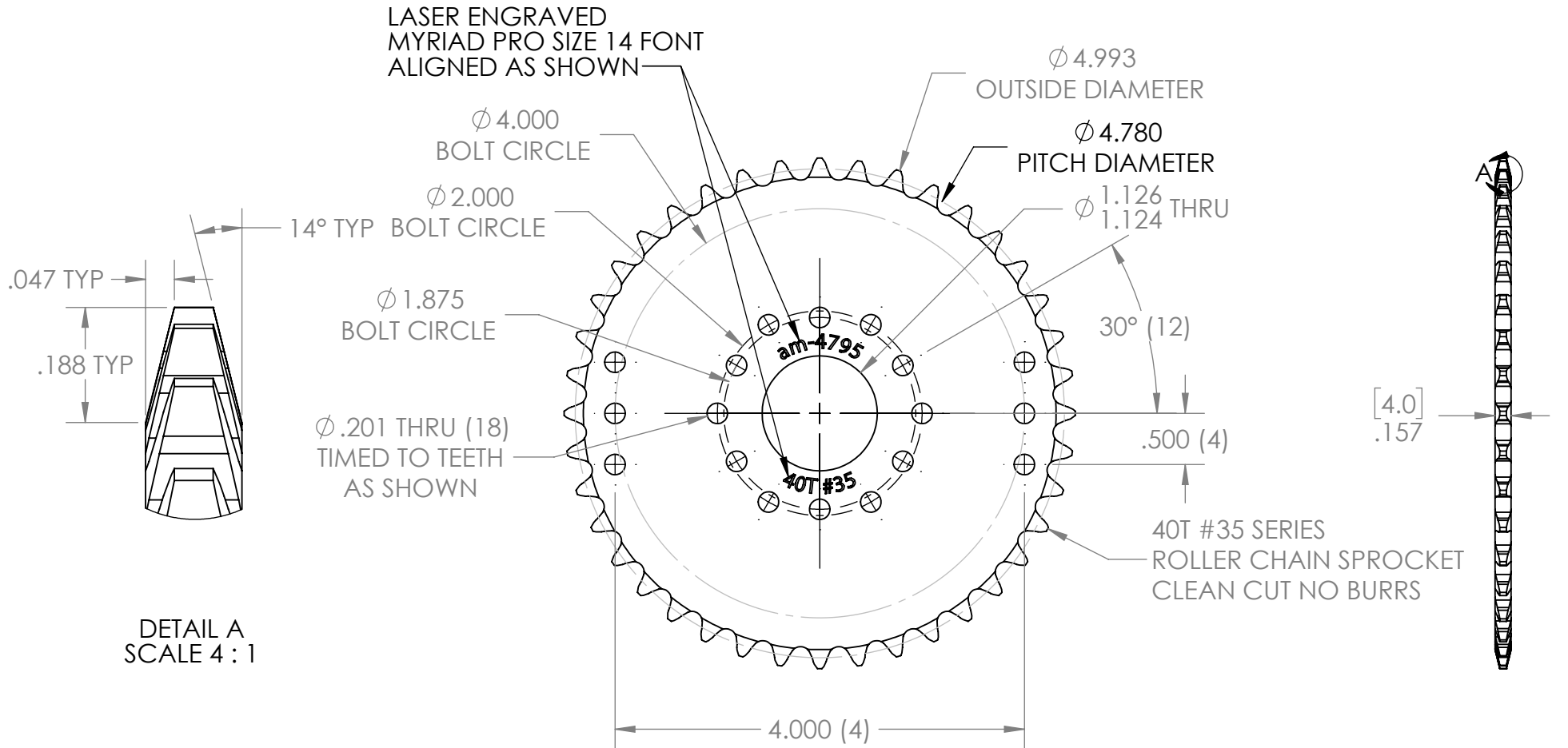

REVISION HISTORY			
REV.	DESCRIPTION	DATE	DRAWN BY
1	ORIGINAL PRINT	7/14/2022	T. JORGENSEN



*** SEE CAD FOR ADDITIONAL TOOLPATH INFO***

UNLESS OTHERWISE SPECIFIED:		COMMENTS:				
DIMENSIONS ARE IN INCHES		DUAL DIMENSIONS ARE IN MILLIMETERS.				
TOLERANCES:		BREAK ALL SHARP EDGES.		TITLE: 40T 35 CHAIN 1 125 IN BORE PLATE SPROCKET		
FRACTIONAL	±1/16			SIZE	DWG. NO.	REV
ANGULAR: MACH	±1°			A	am-4795	1
ANGULAR: BEND	±5°			SCALE: 1:1.5 SHEET 1 OF 1		
ONE PLACE DECIMAL	±0.1					
TWO PLACE DECIMAL	±0.01	MATERIAL 7075-T6 AL				
THREE PLACE DECIMAL	±0.005	FINISH DEBURRED SILVER ANODIZED				
FOUR PLACE DECIMAL	±0.0005	DO NOT SCALE DRAWING				
		CHECKED	NAME	DATE		
		ENG APPR.	NL	7/29/22		
		MFG APPR.				
		Q.A.				

