

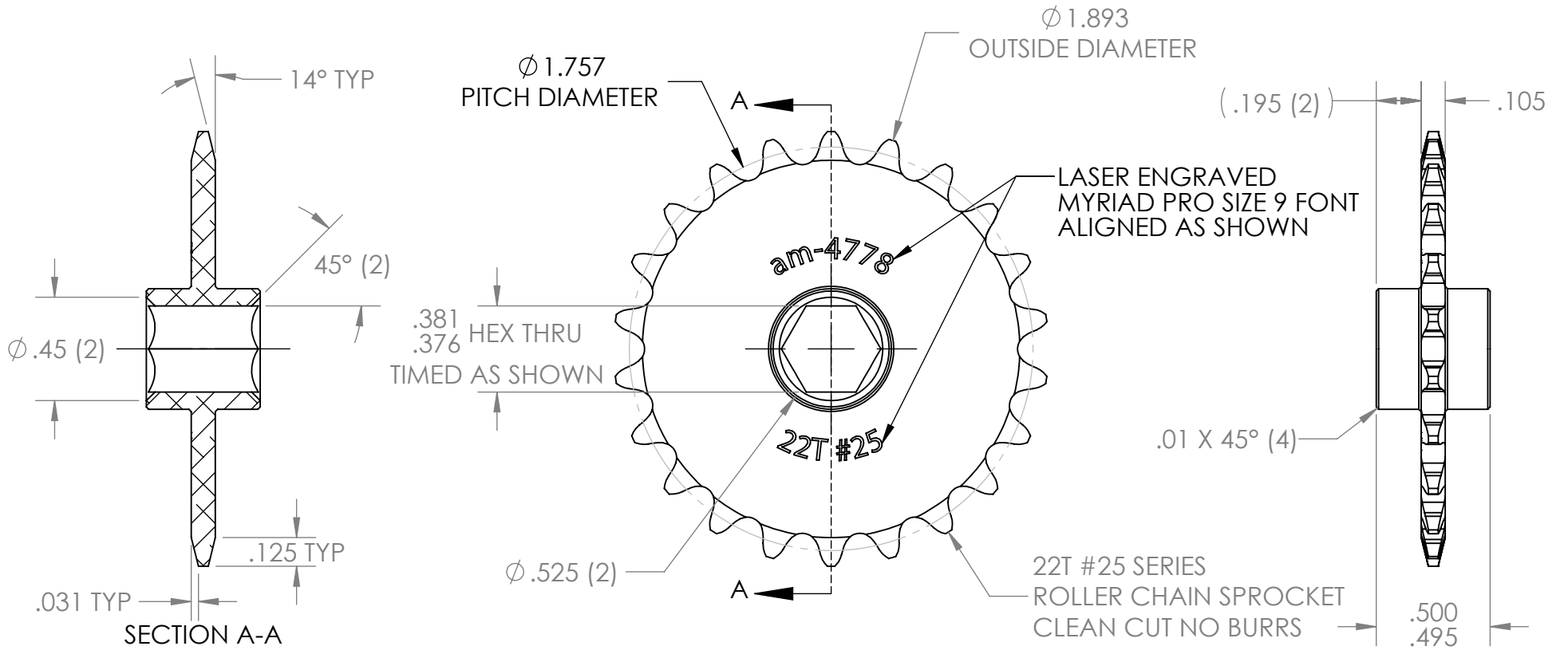

REVISION HISTORY			
REV.	DESCRIPTION	DATE	DRAWN BY
1	ORIGINAL PRINT	7/7/2022	T. JORGENSEN

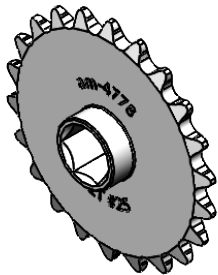

*** SEE CAD FOR ADDITIONAL TOOLPATH INFO***



UNLESS OTHERWISE SPECIFIED:		COMMENTS:				
DIMENSIONS ARE IN INCHES		DUAL DIMENSIONS ARE IN MILLIMETERS.				
TOLERANCES:		BREAK ALL SHARP EDGES.		TITLE:		
FRACTIONAL	±1/16			22T 25 CHAIN		
ANGULAR: MACH	±1°			375IN HEX BORE		
ANGULAR: BEND	±5°			SYMMETRICAL SPROCKET		
ONE PLACE DECIMAL	±0.1			SIZE	DWG. NO.	REV
TWO PLACE DECIMAL	±0.01			A	am-4778	1
THREE PLACE DECIMAL	±0.005			SCALE: 1.5:1 SHEET 1 OF 1		
FOUR PLACE DECIMAL	±0.0005					
MATERIAL	7075-T6 AL	CHECKED	NAME	DATE		
FINISH	DEBURRED SILVER ANODIZED	ENG APPR.	NL	7/29/22		
DO NOT SCALE DRAWING		MFG APPR.				
		Q.A.				