

4

3

2

1

REVISION HISTORY			
REV.	DESCRIPTION	DATE	DRAWN BY
1	DRAFT PRINT	2/29/2024	N. MASSOUDA
2	PRODUCTION PRINT	3/20/2024	N. MASSOUDA
3	REVISED HOLE SIZES AND LOCATIONS	4/24/2024	N. MASSOUDA
4	UPDATED NAME	8/1/2024	N. MASSOUDA

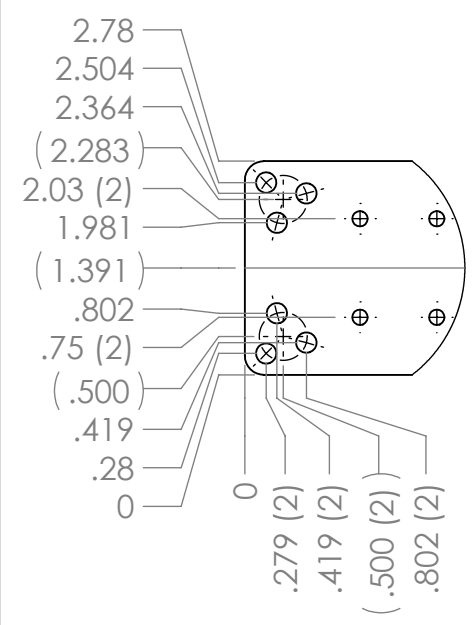

DETAIL A
SCALE 2 : 5

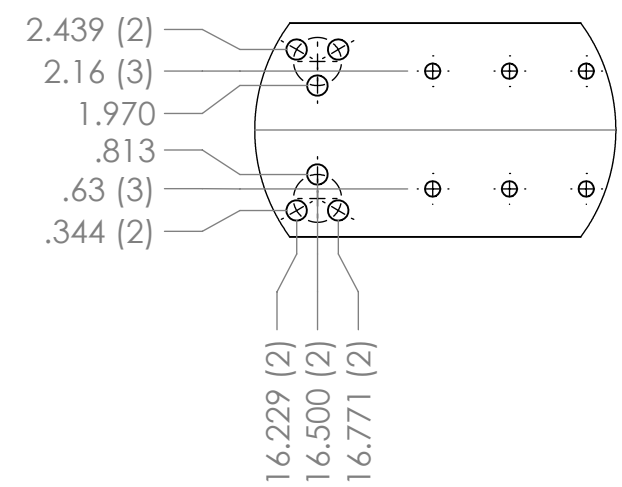

DETAIL B
SCALE 2 : 5

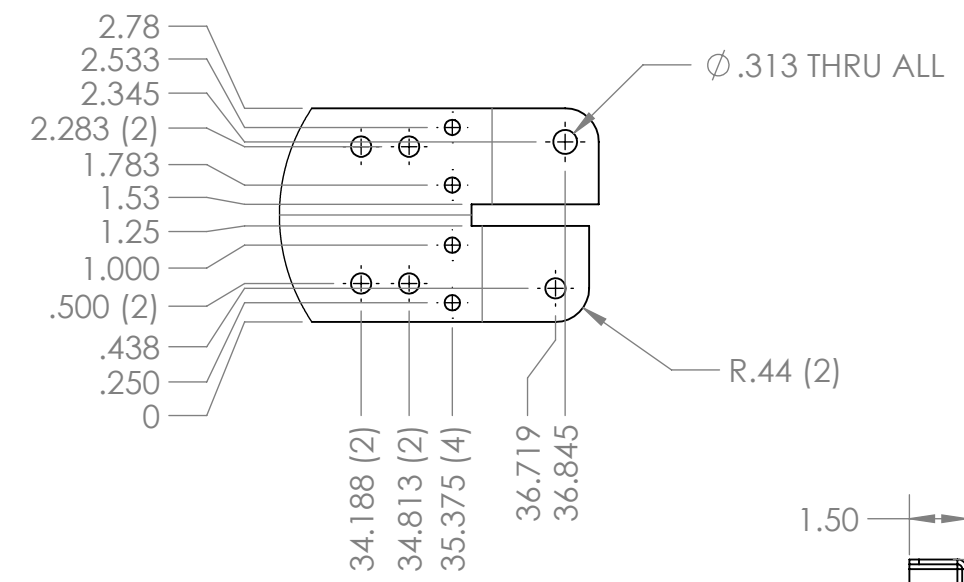

DETAIL C
SCALE 2 : 5

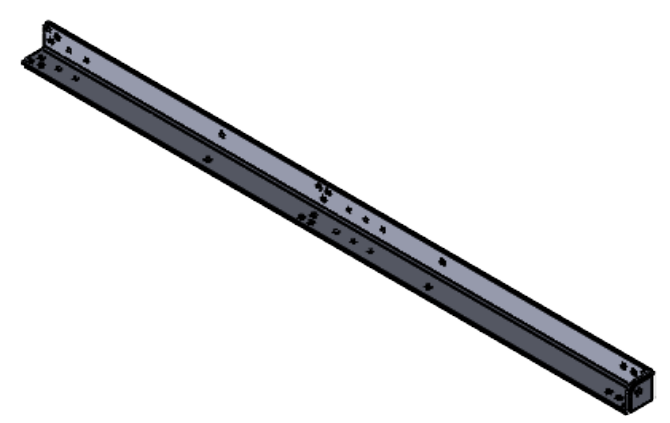
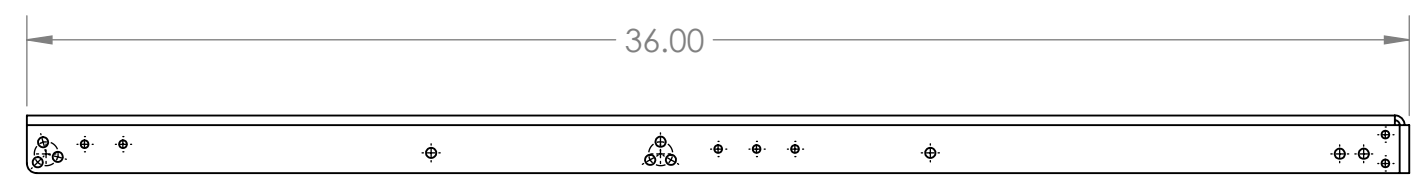
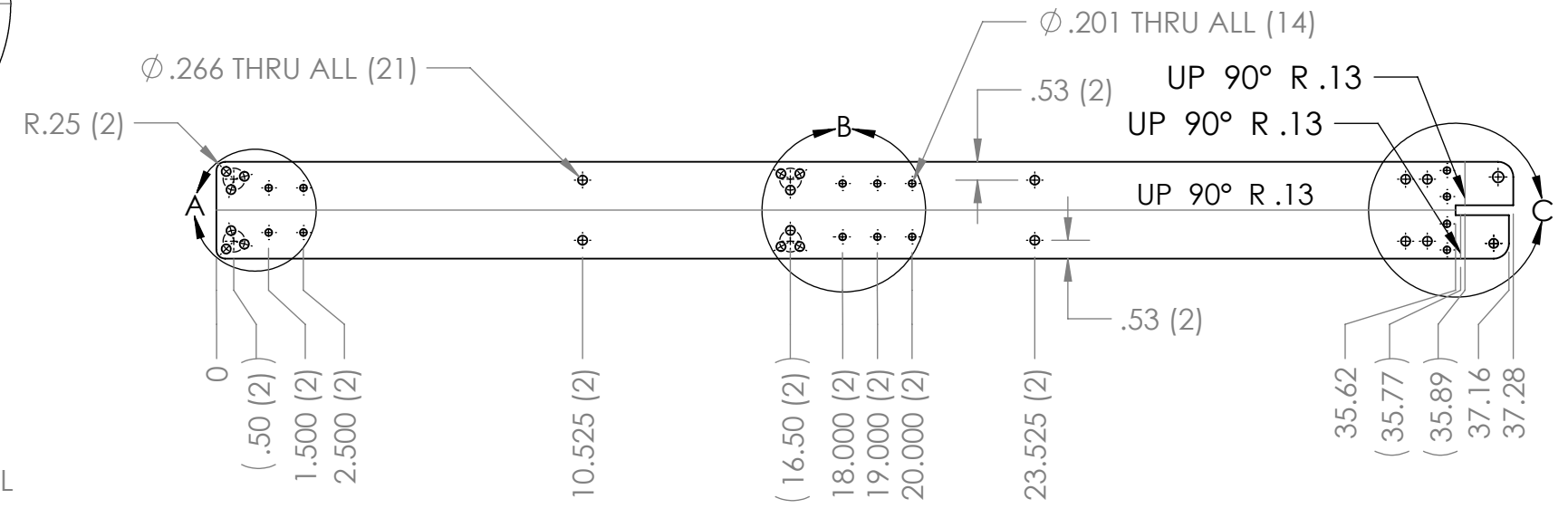
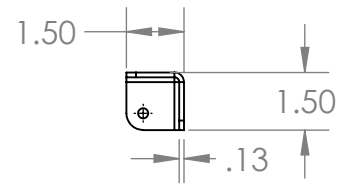

*** SEE CAD FOR ADDITIONAL TOOLPATH INFO***

UNLESS OTHERWISE SPECIFIED:		COMMENTS:				
DIMENSIONS ARE IN INCHES		DUAL DIMENSIONS ARE IN MILLIMETERS.				
TOLERANCES:		BREAK ALL SHARP EDGES.		SIZE DWG. NO. REV		
FRACTIONAL	±1/16			B	am-5419	4
ANGULAR: MACH	±1°			SCALE: 1:5 SHEET 1 OF 1		
ANGULAR: BEND	±5°					
ONE PLACE DECIMAL	±0.1					
TWO PLACE DECIMAL	±0.01					
THREE PLACE DECIMAL	±0.005					
FOUR PLACE DECIMAL	±0.0005					
MATERIAL	5052 AL	CHECKED	NAME	DATE		
FINISH	DEBURRED	ENG APPR.	PY	8/1/24		
DO NOT SCALE DRAWING		MFG APPR.				
		Q.A.				

4

3

2

1